

WyreStorm HDBaseT™ Class D Digital Audio Amplifier / Receiver / Repeater



Part Number AMP-001-010



Instruction Manual



Thank you for choosing this WyreStorm product.
Please read these instructions carefully before installing to avoid complications later.

Contents

- 1** Introduction
- 2** Features
- 3** Safety Precautions
- 4** Package Contents
- 5** Specifications
- 6** Panel Descriptions
 - i. Front
 - ii. Rear
- 7** Connection and Operation
 - i. Cabling Guide
 - ii. RJ45 Termination
 - iii. Initial Connection
 - iv. IR/RS232 Control Connection
 - v. Optional Device Connection
 - Personal Device Audio Input
 - Speaker Connection
 - Subwoofer
 - External Power Amplifier
 - Supported Speaker Types
 - vi. Interface Device
- 8** Basic Operation
- 9** Remote Control Handset Operation
- 10** Onscreen User Interface
- 11** Application Scenarios and installation benefits
 - i. Basic Centralized Source
 - ii. Extended Centralized Source
 - iii. Basic Matrix
 - iv. Extended Matrix
 - v. AMP-001-010 as Display Receiver
 - vi. AMP-001-010 as In-line Solution
 - vii. Central Configuration
- 12** RS232 Application Scenarios
 - i. Understanding RS232 Connection & Signals
 - ii. Zonal IR for Cascading Multiple Independently Controlled AMP units
 - iii. Global IR for Cascading Multiple Collectively controlled AMP units
 - iv. Hybrid IR for combination of Zonal and Global IR control of multiple AMP units
 - v. RS232 Addressing
 - vi. Routable RS232 with Wyrestorm POH-enabled HDBaseT Matrices - MX-PP-POH
 - vii. Residential RS232 HDBaseT Addressing example
 - viii. Example system topology showing multiple, differently addressed amps.
 - ix. Commercial RS232 HDBaseT Addressing example
- 13** EDID Management
 - i. About EDID
 - ii. Before EDID adjustment
 - iii. EDID Pre-sets
- 14** Troubleshooting
- 15** FAQ's
- 16** Maintenance
- 17** Provided Service
- 18** Mail In Service
- 19** Warranty
 - i. Warranty Limits and Exclusions
- 20** Installation Notes

1. Introduction



AMP-001-010 Wyrestorm HDBaseT™ Class D Digital Audio Amplifier / Receiver / Extender

The Wyrestorm AMP-001-010 is a unique HDBaseT™ Class D digital audio amplifier with receiving and repeating functionality that fundamentally changes the way to approach the design of multi-room audio-visual systems.

Fully cascadable (daisy-chained) over multiple 70m/230ft distances up to 7 times using a single Cat5e cable to create larger distributions. It also offers HDMI/HDBaseT reception and pass-thru, 2.1 audio amplification with subwoofer and stereo preouts for connection to an AVR and HDMI breakout with bidirectional control of source/display from either location via IR/RS232.... and so much more.

Feature rich and highly versatile, the AMP simplifies, combines and improves the relationship between HDMI, HDBaseT and stereo audio for integrators by incorporating 3:1 audio switching from centralized AV sources and ARC or local audio input.

Employing a switching topology, the low voltage, energy efficient digital Class D amplification delivers power to the speaker load exclusively with very little power wasted in operation. This increase in efficiency has the main benefit of lowering heat dissipation and reducing the size of the amplifier assembly. If properly executed, most D-class amplifiers typically have a much smaller form factor and a lower BOM cost than comparable Class-A/AB/B units.

In terms of installation, it can be used locally in-room as a display device, remotely in-rack or centrally at any point in-line for one of the most flexible and powerful applications of HDBaseT technology to date.

The AMP-001-010 is the first product of its kind and represents Wyrestorm's innate understanding and appreciation of the AV installation by continually pushing the boundaries of what is possible to offer innovative products that add great value to any residential or commercial application, whatever the size or budget.

www.wyrestorm.com

Part Number AMP-001-010

2. Features

- Combined HDBaseT Repeater, Receiver and Class D Amplifier – all in one.
- Compact and easy to install & use with single Cat5e/6 cabling – applies the same basic integration principles for residential, light or major commercial projects.
- Flexible and versatile – multitudes of application scenarios from basic extender to complex volume digital AV distribution installed at any point during a cable run.
- HDBaseT Input and pass-thru with HDBaseT Output.
- 3:1 Audio Switcher/Receiver – Audio from centralized source via HDBaseT Transmitter or Matrix Device, Audio Return Channel (ARC) or Local Audio Input via 3.5mm.
- AMP used centrally with AV source, In-line near speakers, wall mounted near data connections or locally at display location.
- 70m/230ft transmission distance between device and AMP > then another 70m/230ft to next AMP.
- Fully cascable up to 7 times from single transmitting device (Matrix or HDBaseT transmitter).
- HDMI output for direct connection of HD display either in-line to each AMP connected or at the end of the run.
- 2.1 stereo audio at 25w per channel - amplifier capability to drive 4, 6 & 8 Ohm speaker loads.
- High quality preamplifier adjustment for tone/volume/sub/mute control.
- Variable Analog line level outputs.
- Analog (RCA) Subwoofer output.
- Stereo speaker amplified outputs with left/right spring terminal connections.
- Bidirectional control of source and display via IR or RS232 (IR control signal passed within HDMI transmission).

- Options range from basic control of devices using IR TX and RX ports to fully integrated control via leading control systems using RS232.
- Commands (Tx, Rx, Gnd) sent with HD Audio & Video contained within a single Cat5e/6
- AMPs addressable via RS232 • RS232 Port for firmware update or RS232 control signal transmission.
- EDID management and pre-sets via DIP switch.
- LED indication – power status, audio source selection (HDBaseT, Local or ARC).
- HDMI v1.4 features supported.
- HDCP compliant.
- Internal ESD protection.
- Compact size for flexible integration location.
- Mounting brackets supplied.

3. Safety Precautions



WARNING

To reduce the risk of fire, electric shock or product damage:

1. Do not expose this apparatus to rain, moisture, sprays, drips or splashes and ensure that no objects containing liquids are placed on the apparatus, including cups, glasses and vases.
2. Do not place this unit in a confined space such as enclosed shelving, cabinets or bookshelves. Ensure the unit is adequately ventilated.
3. To prevent the risk of electric shock or fire hazard due to overheating, do not cover the unit or obstruct ventilation openings with material, newspaper, cardboard or anything that may restrict airflow into the unit.
4. Do not install near external heat sources such as radiators, heat registers, boilers or any device that produces heat such as amplifiers or computers and do not place near sources of naked flame.
5. Unplug apparatus from power supply during lightning storms or when unused for long periods of time.
6. Protect the power cable from being walked on, pinched or restricted in any way, especially at plug connections.
7. Only use attachments/accessories specified by the manufacturer.
8. Units contain non-servicable parts - Refer all servicing to qualified service personnel.

4. Package Contents

1 x AMP-001-010 HDBaseT Digital Amplifier main unit	1 x Remote control handset
1 x Printed product manual (also downloadable at www.wyrestorm.com)	2 x Installation brackets (recommended)
1 x USB flash drive containing control software and digital product manual	1x USB - Serial Cable (pheonix connector)
1 x 18v DC power supply	
1 x IR TX transmitter	
1 x IR RX receiver	

5. Specification

Operating Temperature Range	-5 to 35°C (-41 to +95°C)
Operating Humidity Range	5 to 90 % RH (no condensation)
Output Bandwidth Signalling Rate	6.75Gbps
Input Video Signal	0.5 - 1.0 volts p-p
Input DDC Signal	5 volts p-p (TTL)
Maximum Single Link Range	1080p 36bit Deep Colour
Transmission Distance	1080p signal up to 70m/230ft
Video Format Supported	VESA: 640x480, 800x600, 1024x768, 1280x1024, 1600x1200, 1920x1200 DTV/HDTV 480i/576i/480p/567p/720p/1080i/1080p
Output Video	HDMI 1.4v - repeats source to sink HDCP compliant full 3D compatibility with frame packing/sequential (Blu-ray) and Stereoscopic (satellite/cable broadcasts) ARC supported
Audio Format Supported	DTS-HD Master Audio, Dolby True HD - 2.1 PCM / 4,6, 8 ohmspeaker impedance
Max. Transmission Distance over HDMI	Max. 15m/49ft (using good quality HDMI cables) - HDMI to HDMI Coupler can be used to extend HDMI transmission further if need be.
BTU Rating (British Thermal Unit)	153.54
Power Consumption	45 Watts
Power Supply	18v DC
Dimensions	202mm/8.0" x 31mm/2.1" x 178mm/7.0"
Weight	1kg/2.2lbs
Rack Space Required	N/A

6i. Panel Description - Front

- 1 Amplified passive speaker output with spring terminal connections - Connecting minimum power handling of 25 Watts RMS per channel accepting 4, 6 or 8 Ohm impedance.
- 2 Analog Subwoofer Pre-out for external connection of active sub woofer accepting single Mono/LFE RCA Input.
- 3 RS232 serial control port – for direct and local control of AMP through third party control systems or PC. Software provided for connection to a control system - see www.wyrestorm.com for protocols for leading Control Systems.
- 4 HDBaseT IN – HDBaseT input accepting full HD video, HD audio and control signals from centralized source over a single Cat5e/6.

- 5 Pre-out Stereo Audio Output (DAC > Digital Analog Converter) for direct connection to external amplifier/AVR via stereo RCA cables (Note: when external power amplification is used, speakers and Subwoofer should be connected directly to the AVR).
- 6 IR RX control receiver port - for receiving infrared control signals and sending back to centralized source & AMP function control.
- 7 IR TX control transmitter port - For transmitting infrared control signals from central location to control TV function.

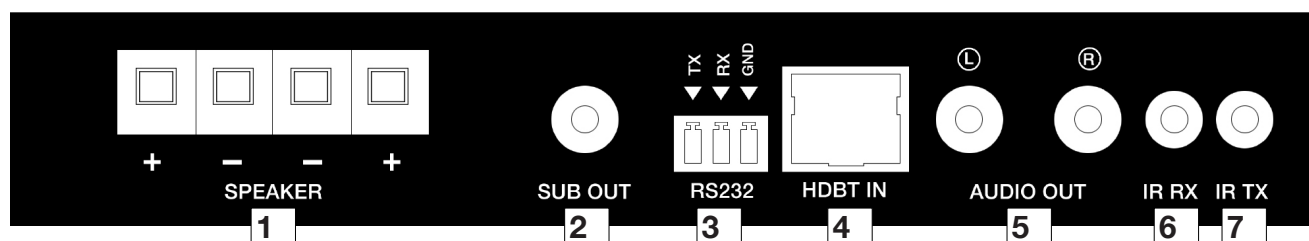

6ii. Panel Description - Rear

- 1 Power ON/OFF switch – lit when powered (standby via remote control handset)
- 2 HDBaseT output – repeats HDBaseT transmission a further 70m/230ft to another AMP-001-010 or RX-1UTP-IR-70 receiver to end the distribution, including embedded IR/RS232 commands.

Attention: Maximum number of AMPs that can be daisy-chained is 7

- 3 HDMI output – for connection to a local HDMI display device, including ARC return path
- 4 EDID DIP Switch – manual EDID management enables immediate EDID data feedback to the display to overcome any communication issues encountered between connected devices - includes 3D and Long cable mode (see EDID settings section)
- 5 Audio Source Select button – press to manually toggle through local audio, ARC or HDBaseT audio sources (Lit for selected)
- 6 Audio Source LED indication – displays currently active audio source.
- 7 Audio selected – 2ch stereo or 2.1ch stereo audio selected
- 8 IR status – confirms IR receiver activity
- 9 L/R Line level local audio source input – 3.5mm mini jack
- 10 18vDC Power input – screw-lock connector (please use power supply provided)

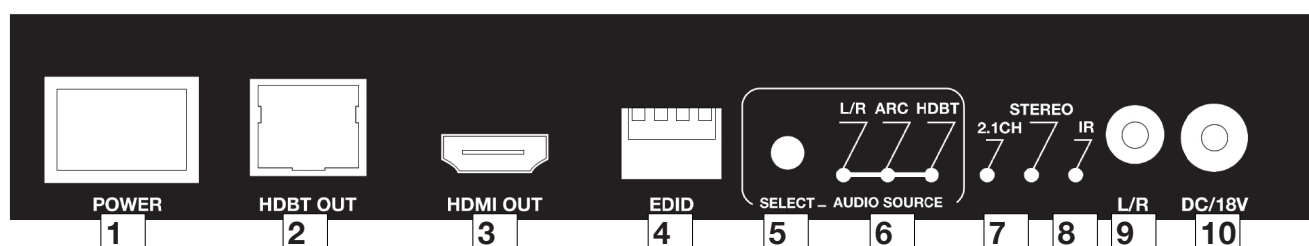

7i. Connection & Operation - Cabling Guide

Multiple Inputs via MX0808-PP with additional Local audio input & ARC

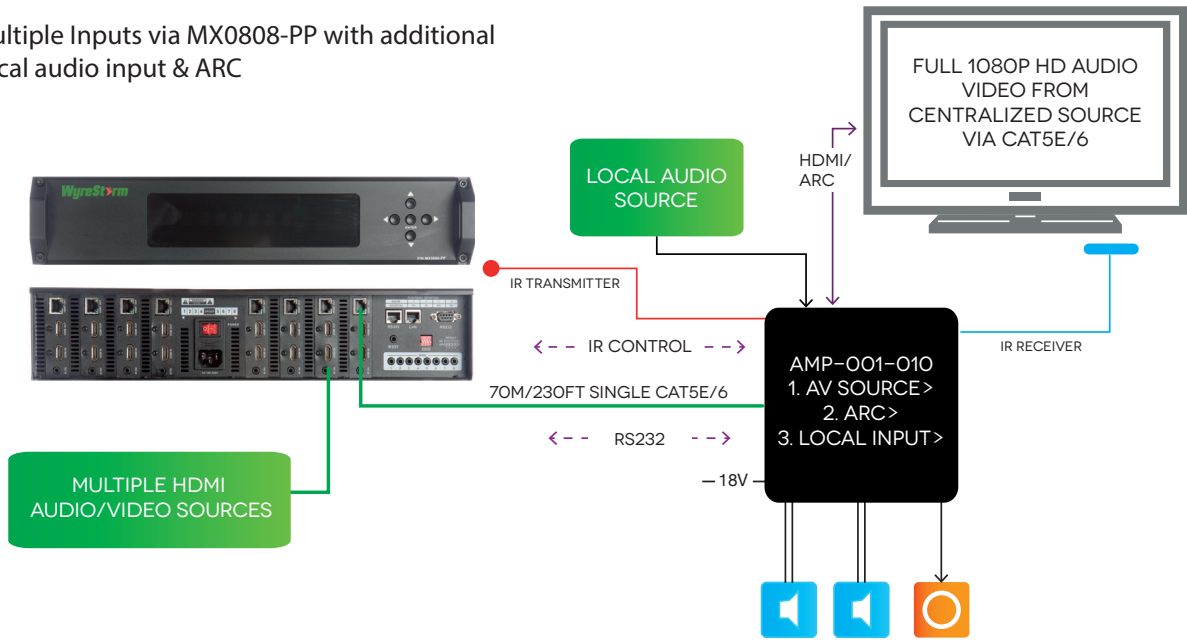

Extended Multiple Inputs

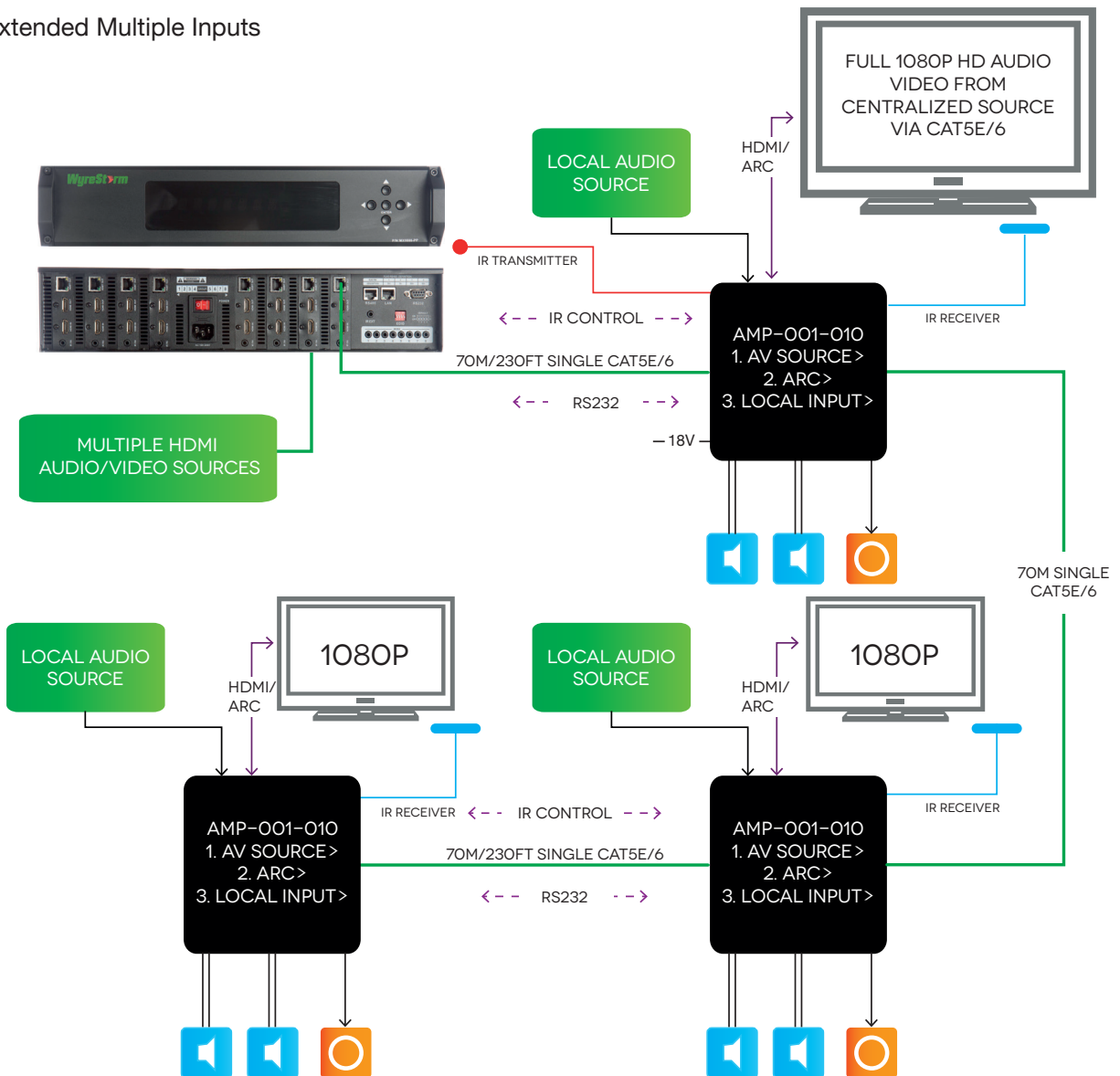

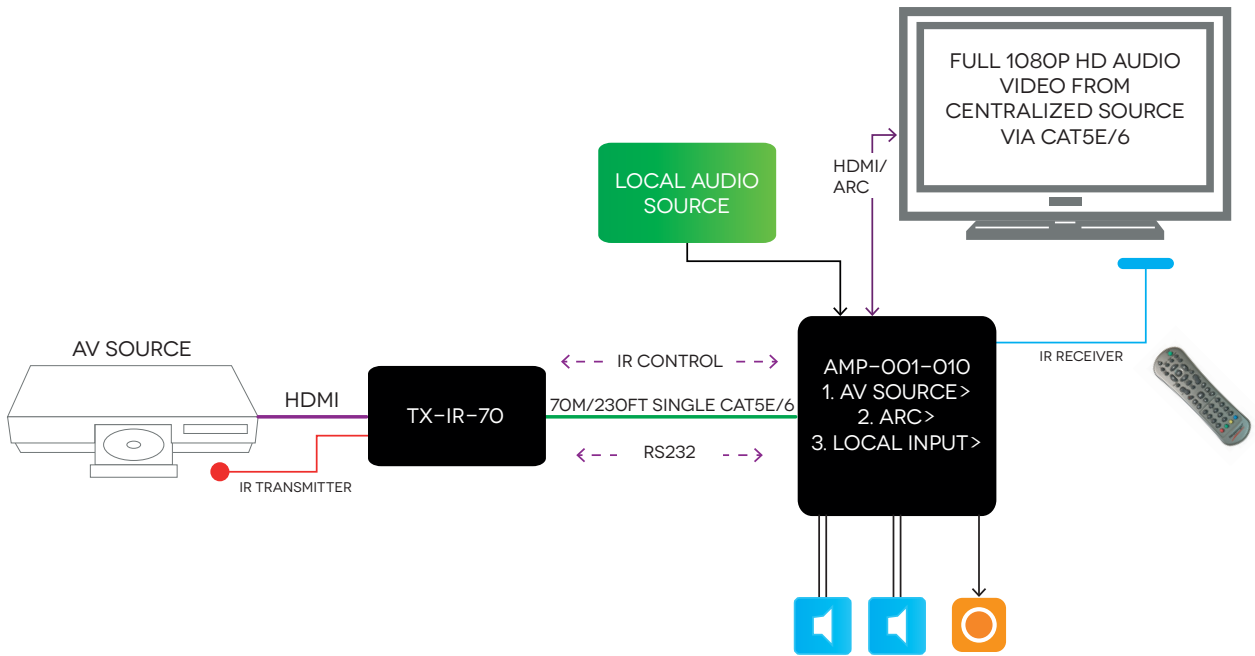

Extended Multiple Inputs

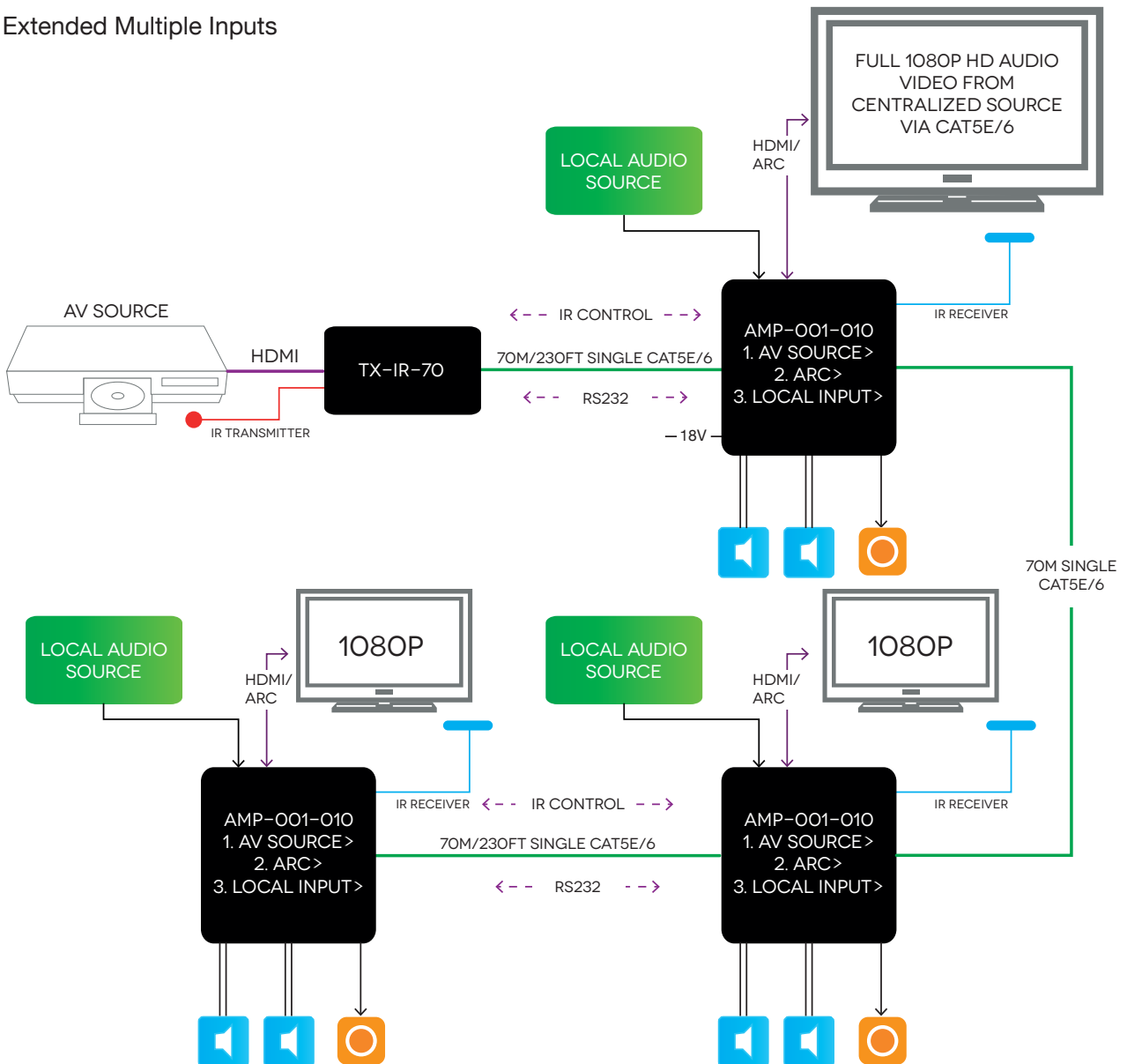

AMP-001-010 Centralized with Wyrestorm Matrix with managed Lip Sync

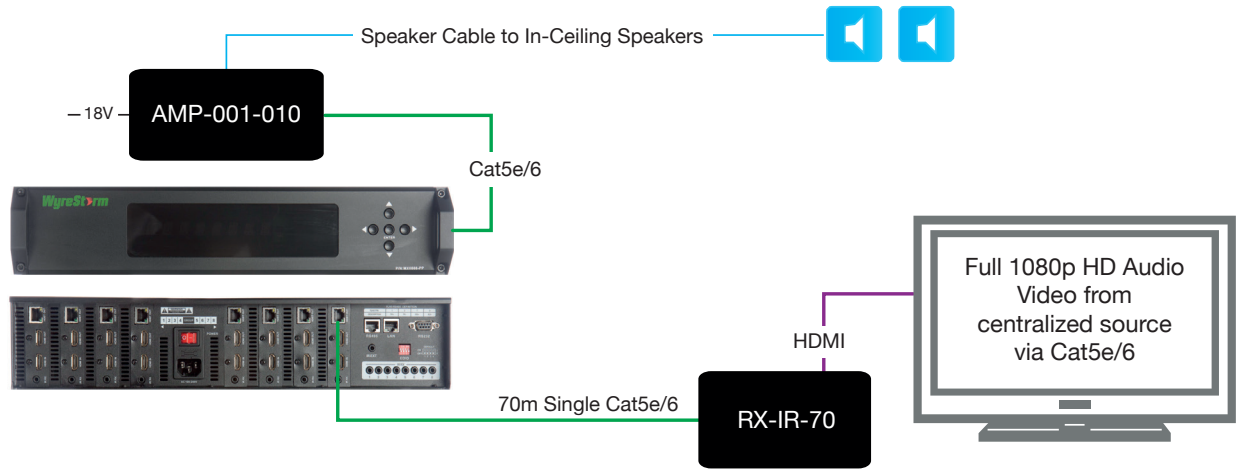

AMP-001-010 In-line adjacent with In-Ceiling speakers

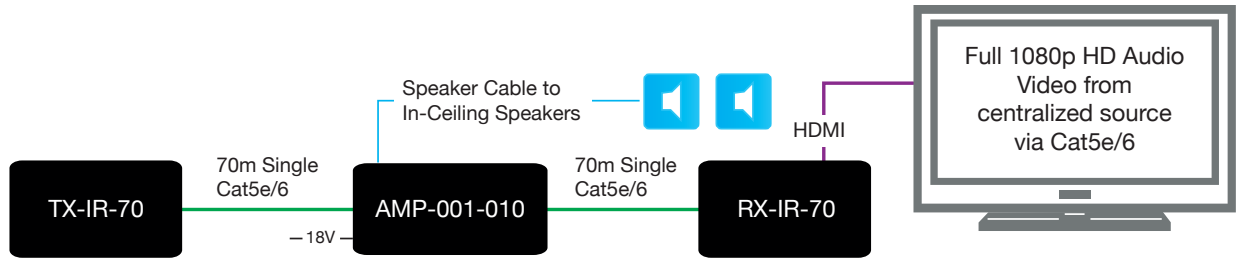

AMP-001-010 In-Line and Cascaded with In-Ceiling Speakers

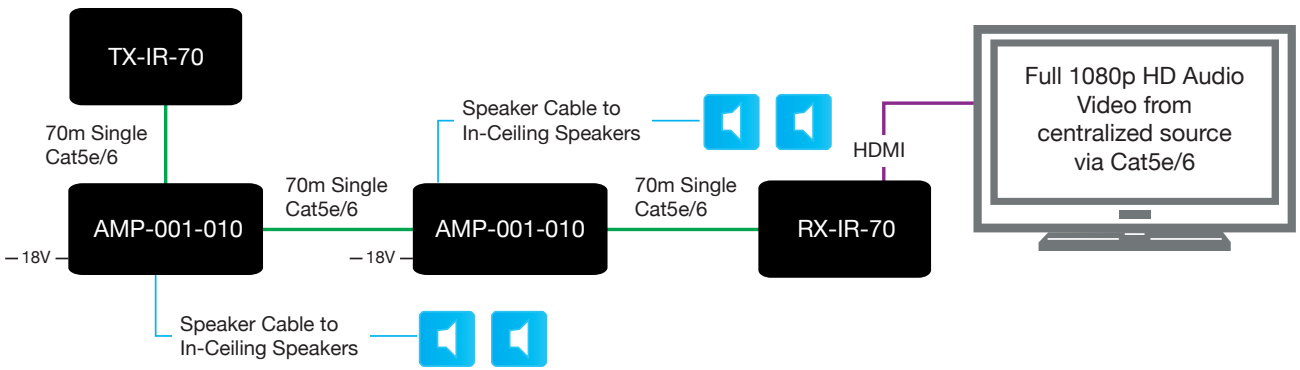

AMP-001-010 as a Receiving Display Device

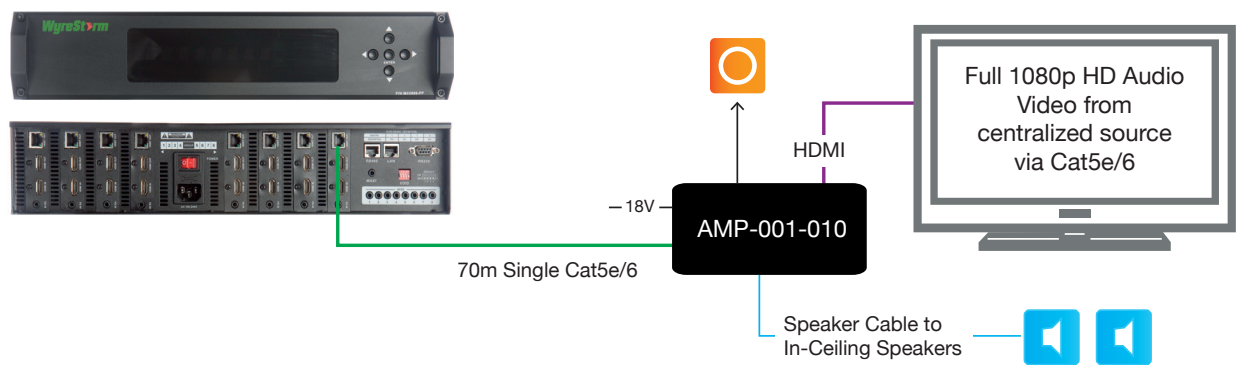

7ii. RJ45 Termination

Cat5e Wiring Guide

The quality of termination for every RJ45 is essential. Poor terminations leads to intermittent performance and longer install times



Cat5e Cable Performance Guide

5m	10m	15m	20m	25m	30m	35m	40m	45m	50m	60m	70m	
HDBaseT Class D Digital Audio Amplifier / Receiver / Repeater AMP-001-010												
16ft	32ft	49ft	65ft	82ft	98ft	115ft	131ft	147ft	164ft	197ft	230ft	
1080p 1080i												

7iii. Initial Connection

1 Connect an HDMI input (such as DVD, Blu-Ray, PS3, Satellite, Cable, media server, computer etc.) to an HDBaseT transmission source (such as a Wyrestorm TX-1UTP-IR-70 transmitter or a MX-PP matrix solution).

2 Connect a good quality, well terminated Cat5e/6 cable of no more than 70m/230ft between the HDBaseT output of the HDBaseT transmission device to the HDBaseT Input of the AMP-001-010

Attention: 70m/230ft is the maximum recommended transmission distance for this classification of HDBaseT equipment and denotes perfect transmission conditions - including straight cable runs with no electrical interference, bends, kinks, patch panels or wall outlets. If any of the above are a factor in your installation, transmission range may be affected – take care to avoid where possible.

3 Connect the HDMI sink (such as High Definition LED/Plasma flat panel display or HD Digital projector) to the HDMI Output of the AMP-001-010

4 Connect another well terminated and good quality Cat5e/6 cable from HDBaseT output of the AMP-001-010 to HDBaseT input of a Wyrestorm HDBaseT Receiver device (such as an RX-1UTP-IR-70 receiver, or another AMP-001-010)

Attention: The AMP-001-010 can be used as both an HDBaseT repeater to extend the transmission as well as a Receiver, with the inclusion of up to 7 units connected along a single cable run. As such, an RX-1UTP-IR-70 receiver is only required to extend the final leg of the distribution a further 70m/230ft, or if HDMI output and IR/RS232 control only is required.

5 As before, connect the HDMI sink (such as High Definition LED/Plasma flat panel display or HD Digital projector) to the HDBaseT Output of the HDBaseT Receiver device.

Repeat process for all AMP-001-010 units installed along your cable run.

7iv. IR/RS232 Control Connection

1 For two way control of connected sources and displays from either location, connect IR TX infrared transmitter emitters to the IR TX ports of the HDBaseT Transmitter devices and AMP-001-010.

2 Insert IR RX infrared receiver emitters into IR RX ports of the HDBaseT Receiver devices and AMP-001-010.

3 If using an RS232-based control system, insert cables into the RS232 ports of devices to enable RS232 control signal transmission (Default set for RS232).

4 Connect the AMP-001-010 to a mains power source using the 18vDC power supply included.

Attention: The AMP-001-010 is capable of Power-over-HDBaseT passthrough distances up to 50m/164ft when used between PoH-enabled devices such as a MX-PP-POH matrix or POH transmitters and receivers.

The AMPs themselves will still require mains power for operation but are able to passthrough power from a PoH transmission device to a PoH receiver to negate the need for mains power at the display end.

7v. Optional Device Connection

1 For connection of local line level audio sources (such as MP3 player, multiroom audio system, laptop/desktop, smartphone/tablet, mixer, microphone etc) connect a 3.5mm mini jack from the audio source to the L/R port of the AMP-001-010

2 To connect stereo speakers directly to the AMP-001-010, insert evenly stripped, good quality copper cable of adequate gauge into the SPEAKER spring terminal connections of the AMP-001-010 with care taken to insert wires into correct spring clips based on audio signal polarity (+/+, -/-). Ensure plastic insulation is undamaged and cable is untangled, without bends or kinks that may interfere with transmission.

Attention: Maximum output available 25w per channel

3 For increased bass range, an active subwoofer can be connected to the SUB OUT port of the AMP-001-010

4 For additional amplification, the AMP-001-010 can be connected to an external power amplifier or AV Receiver (AVR) via the stereo AUDIO OUT ports.

Attention: In such cases where an AVR is used, the SUB OUT of the AMP-001-010 should be connected to the SUB Input of the AVR and a subwoofer connected to the AVR. Likewise, speakers should be connected directly to the AVR rather than the spring terminal connectors of the AMP-001-010.

7vi. Interface Device

Using the Audio Pre-Out you can connect the AMP to a multi-room audio amplifier system or separate power amplifier, and expand beyond a basic stereo pair.

8. Basic Operation

The AMP-001-010 can be controlled locally via the front panel or remotely using the handset provided or an RS232 third party control system.

1 Turn on the AMP-001-010 using the POWER switch on the front panel – LED will indicate power status.

2 Select the AUDIO SOURCE by pressing the SELECT button – LED will indicate selection

9. Remote Control Handset Operation

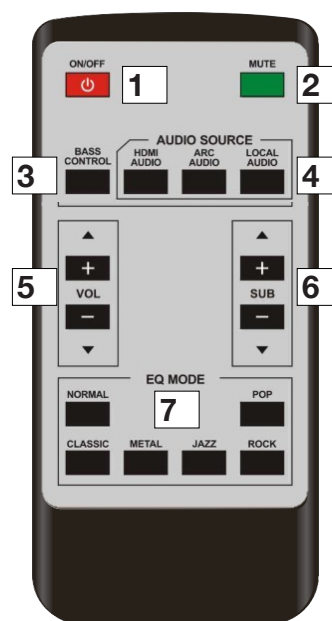

1 Toggle standby mode to power down unit when not in use.

2 Toggle mute function temporarily disables audio output

3 Bass Control button, enable/disable internal crossover to route bass signals to sub pre-out or main speaker output.

4 Source selection to output audio from the main HDBaseT input, local input jack or ARC from locally connected TV.

Attention: TV must have ARC function and be connected to the relevant HDMI port

5 Increase/decrease main speaker volume. This does not control the line level pre-out, this is a fixed output.

6 Adjust output level of subwoofer pre-out port.

7 EQ selection buttons to equalize audio signal depending on your taste.

10. Onscreen User Interface

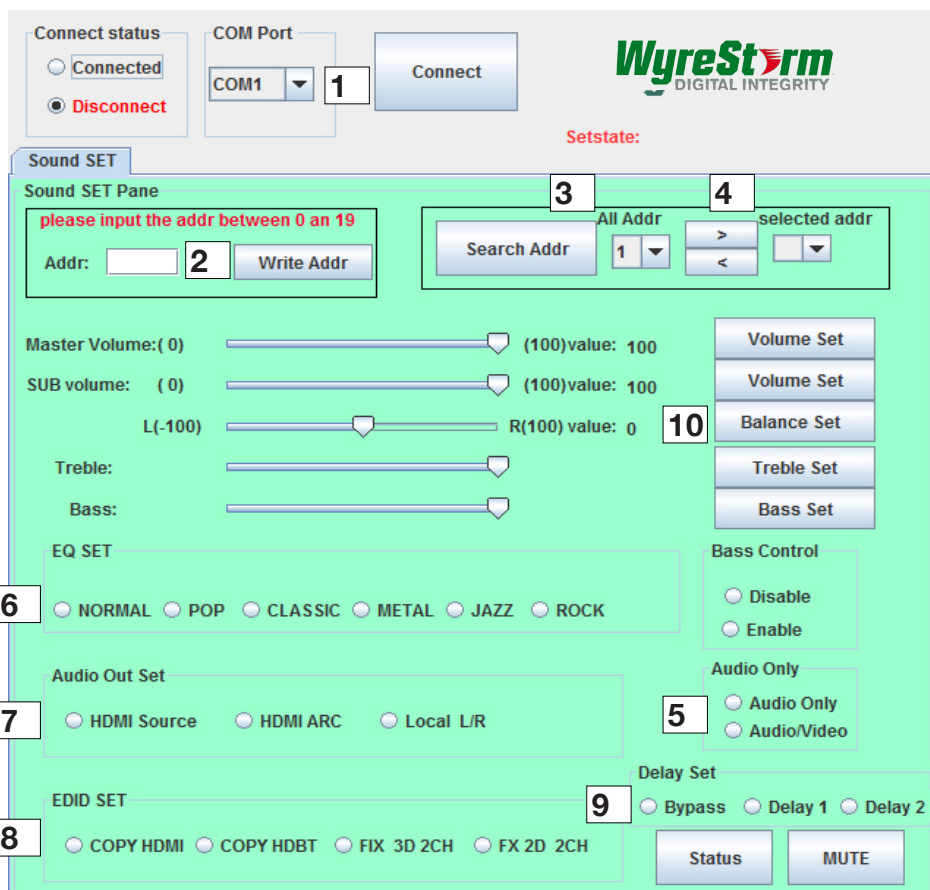

Attention: Amps must be individually connected and have their addresses assigned first, before installation.

Connect the (provided) RS232 cable to a laptop Via USB port to Determine the COM Port

Com Port Connection Status

On opening the User Interface, press Connect to establish a connection with assigned AMP units and control settings. Connection status is illustrated by text colour/selection icon - when connected, the only option will be to press Disconnect and vice versa.

1 Connecting AMP via USB or Serial

The COM Port setting within the AMP software must match the COM Port that your PC has assigned to the USB - Serial Cable.

2 Designate an Address for each Amp that will be connected to the system. Choose a number between 0 and 19 to be the address and click "Write Addr"

3 Click Search Address

The 'Address' you typed in should populate under 'All Addr'

4 Click the Right Arrow '>'

The 'Address' should show up under 'selected addr'

5 If there is no TV/Display connected to the AMP

'Audio Only' needs to be clicked

6 EQ can be set manually to Normal, Pop, Classic, Metal, Jazz, or Rock

7 Audio can be switched manually to HDMI Source, HDMI ARC or Local L/R

8 EDID can be set manually to Copy HDMI, Copy HDBaseT, Fix 3D 2CH or Fix 2D 2CH

9 Lip sync can be set manually to Bypass, Delay 1 or Delay 2

10 Master Volume, Sub Volume Balance, Treble and Bass can all be set manually

Slide Volume Bar & Click 'Volume Set'
Slide SUB Volume Bar & Click 'Volume Set'
Slide Balance Bar & Click 'Balance Set'
Slide Treble Bar & Click 'Treble Set'
Slide Bass Bar & Click 'Bass Set'

11i. Application Scenarios and Installation Benefits - Basic Centralized Source

AMP as Cat5e Extender/Receiver

No compromise in extender performance – 1080p 36Bit

The most progressive extender solution currently available

Overcome your competitors with a better solution

Huge up-sale opportunities from conventional extender product

Higher Value, Add Speakers, Subs, Cables to increase profit

Sending IR to display from a control system

Useful for screen functions such as AV Input, ARC selection or power functions via a control system

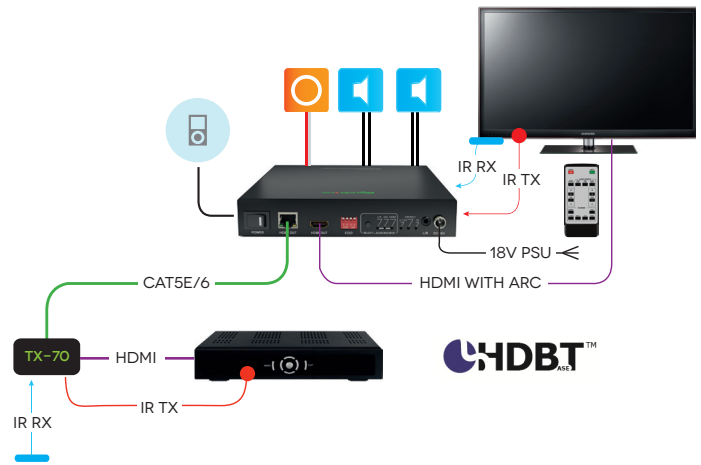

11ii. Extended Centralized Source

HDBaseT Output Connection

Amp functions as transmitter and receiver to enable up to 7 AMPs to be cascaded within a single zone using HDBaseT Out to HDBaseT In ports on units.

Access to Central and Local Source

Each Amp has access to a central source, whether a matrix switcher or a single HDMI input via an HDBaseT Transmitter, also maintains its own personal audio and ARC Inputs.

Maintain Central Source Control

Central Source Control is achieved with IR Receivers at each display.

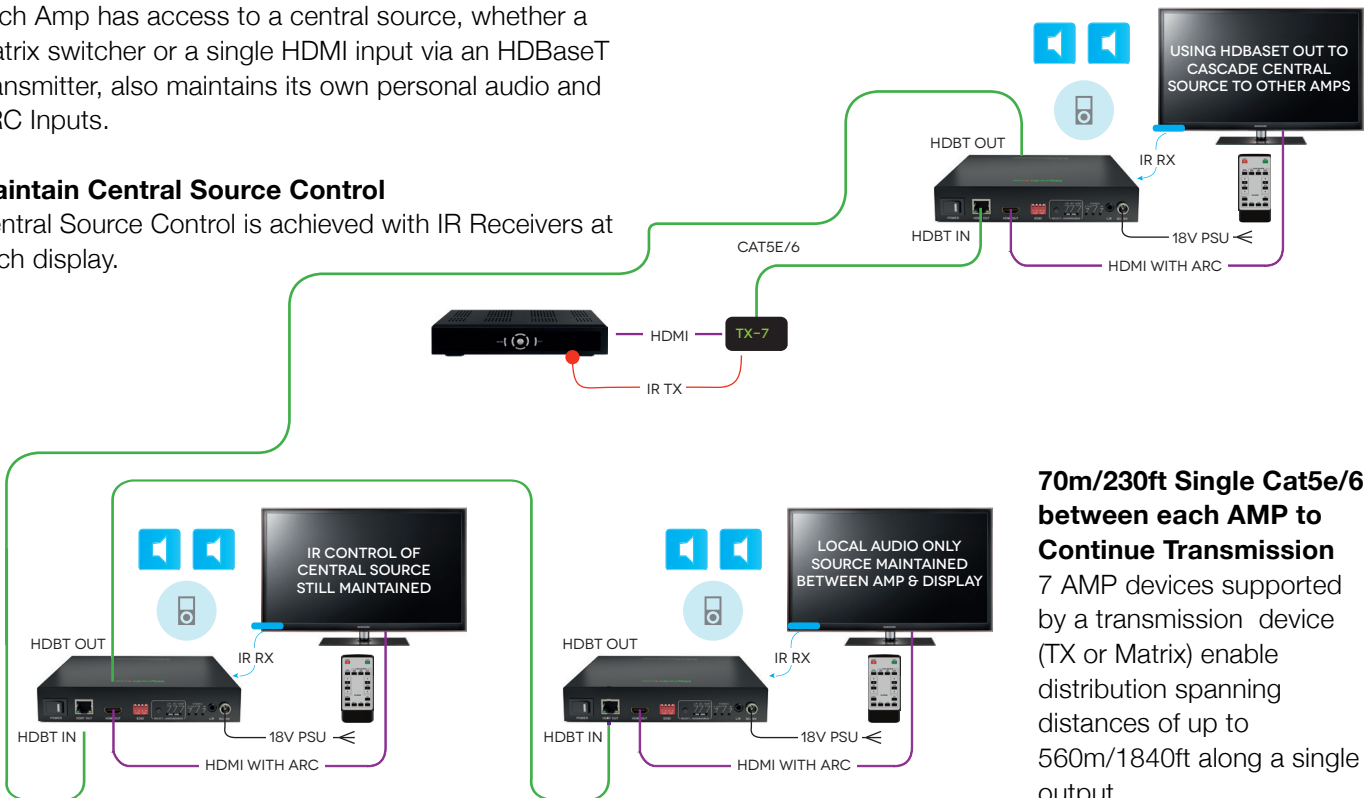

70m/230ft Single Cat5e/6 between each AMP to Continue Transmission
7 AMP devices supported by a transmission device (TX or Matrix) enable distribution spanning distances of up to 560m/1840ft along a single output.

11iii. Basic Matrix

4x4, 6x6, 8x4 or 8x8 Pro Plus Matrix Solution

Add 4, 6 or 8 centralized sources while maintaining full AMP integration as a Amplifier, Receiver, Transmitter and repeater for even greater flexibility for residential and commercial applications.

HDBaseT Output on Each Matrix Output

Same cable transmission as a basic single source system, with the same advantages of HDBaseT technology... multiplied.

AMP as HDBaseT Receiver... and Then Some

Each AMP performs the same transmission receiving functions of centralized sources as an RX70-IR-PP Display Receiver, but adds ARC, personal audio input, Stereo breakout to local amplification and 2.1 audio breakout for greater options at the display end.

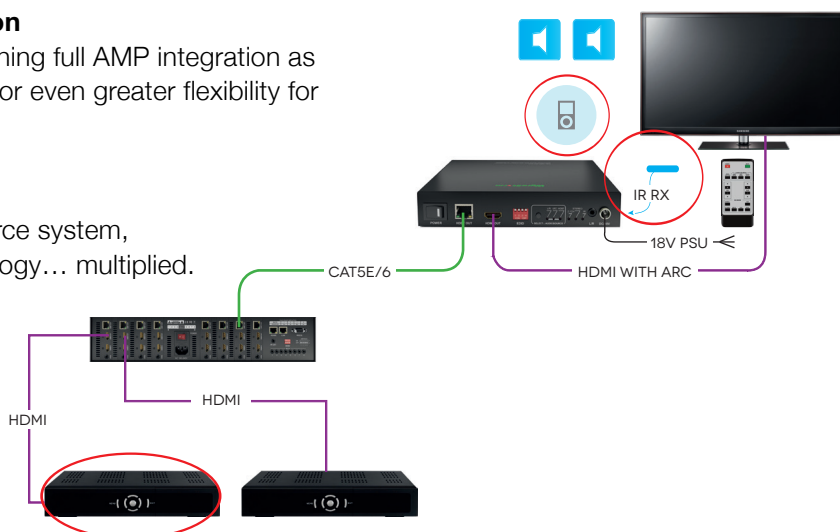

Personal Audio Connection with Overlay

Local audio input can overlay the central source video for additional audio options, such as internet radio sports commentary over a live satellite broadcast, or jukebox over TV news or a Blu-Ray movie.

Same IR receiver function

IR receiver "eye" on displays now handles AMP function, matrix switching function & central source control.

11iv. Extended Matrix

As Easy as Single Source Transmission

The same principle as a single source with a single transmitter, but with the matrix multiplying that process for multiple outputs.

HDBaseT Output on Each Amp

Extend distribution as AMPs also function as a repeater to transmit signals a further 70m/230ft to the next Amp in the chain, then another, and another...

IR RX at Display Location

Control of all multiple sources, AMP functions and matrix control at each display location.

Larger Distribution

With 7 AMPs per matrix output, a network of up to 56 screens is easily achievable with an 8 output Pro Plus matrix, each with localized amplification and personal audio input where needed.

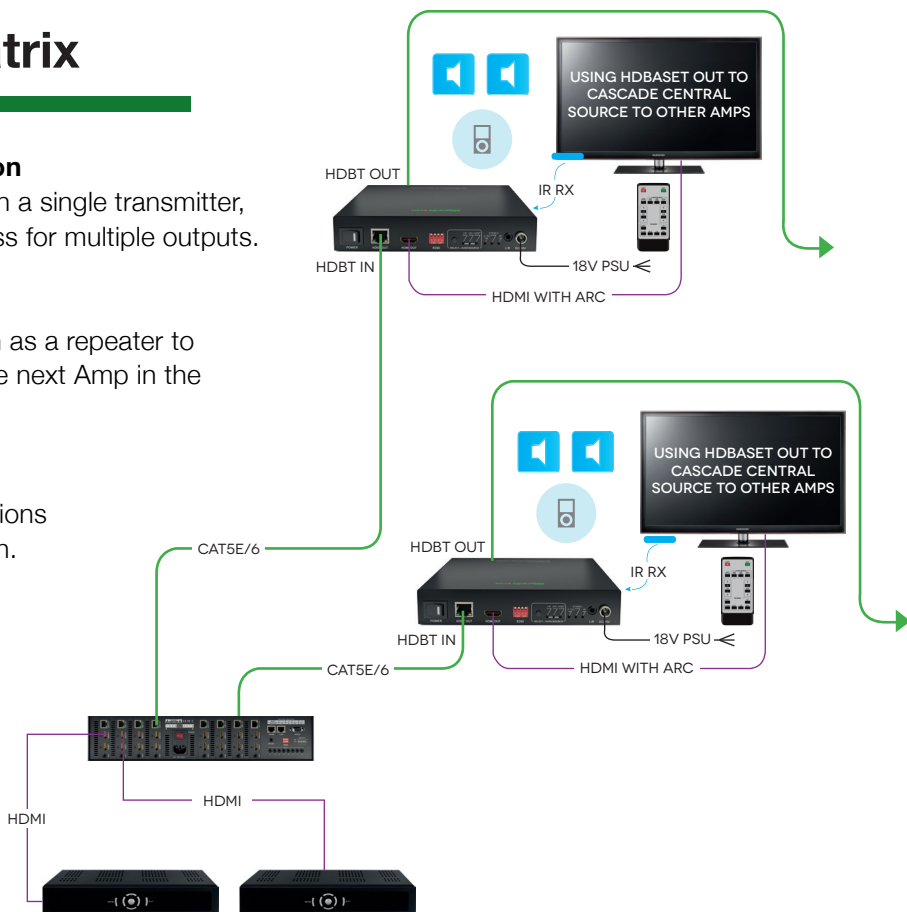

11v. AMP-001-010 as Display Receiver

AMP as a Receiving Device

Simple installation of the AMP between a transmission device and the display, with local, direct speaker connection.

Choice of Transmission Device

Single source transmitter or multi-source matrix - the choice is yours - the installation procedure is identical.

Single Cat5e/6 Cable up to 70m/230ft

Delivers full 1080p 36bit HD video to display, high quality digital audio to amplifier, as well as sending and receiving IR bidirectionally all through HDBaseT.



11vi. AMP-001-010 as In-line Solution

AMP as an in-line device*

Simple and cost effective solution for distribution incorporating in-wall or in-ceiling speakers between an EX-1UTP-IR-70 HDBaseT extender set for total distance of 140m/460ft.

Covers Longer Cable Runs

70m/230ft from Transmitter to AMP, then another 70m/230ft from the AMP to the Display Receiver.

AMP Control Maintained

Control of central source and AMP still possible from display Location, including AMP stand-by function.

*ARC not supported in this instance

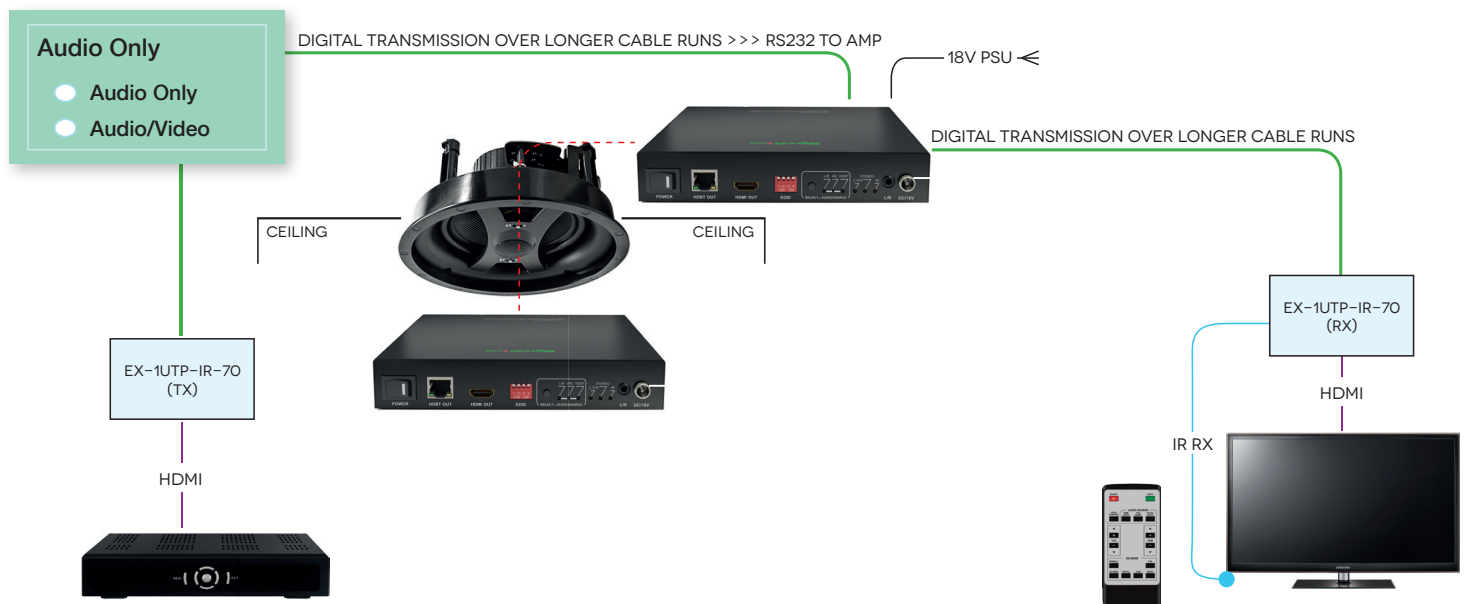

11vii. Central Configuration

AMP Located Centrally*

AMP can be positioned at a central point, such as a rack, and connected to the transmission device via a short patch lead.

Managed Lip Sync Set Via PC

As mixing analog audio and digital video can often cause sync issues, the AMP contains settings and software to overcome such difficulties.

*ARC not supported in this instance

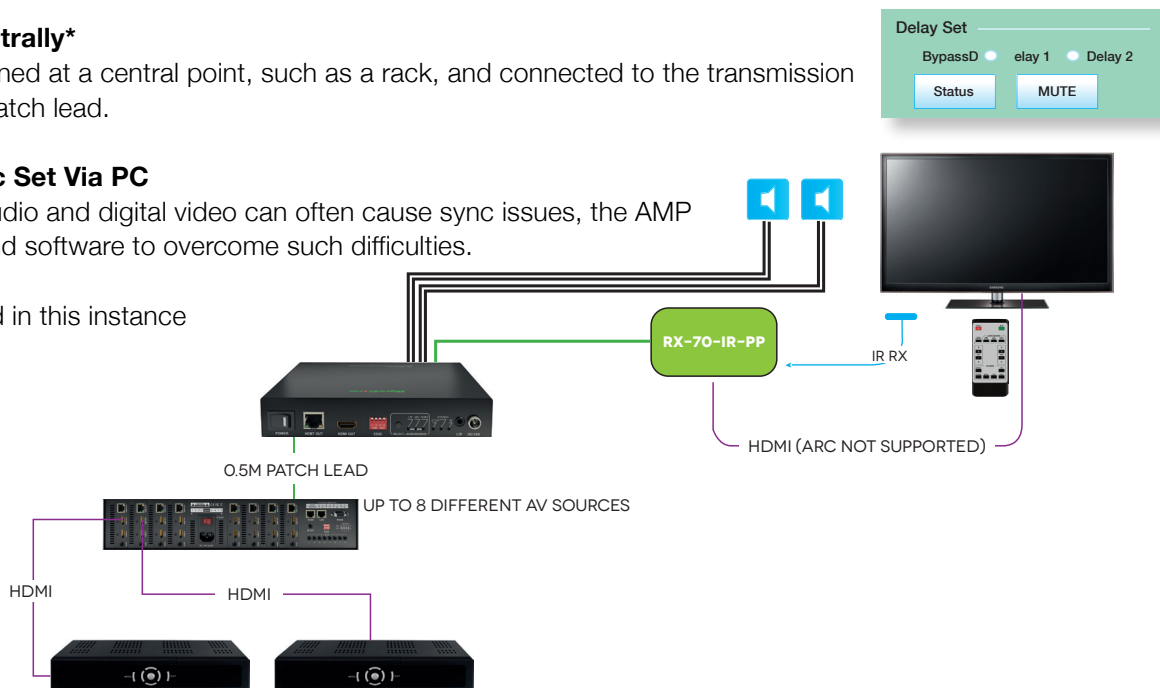

12i. RS232 Application Scenarios - Understanding RS232 Connection & Signals

RS-232C, EIA RS-232, or simply RS-232, refers to the same standard defined by the Electronic Industries Association in 1969 for serial communication.

DTE and DCE

DTE stands for Data Terminal Equipment. A computer or control system is DTE and connects to Data Communication Equipment, or DCE such as an AMP, matrix or modem.

DTE equipment typically feature a Male Connector, while DCE contain a Female Connector, although that is not always true - a simple way to confirm is to measure Pin 3 and Pin 5 of a DB-9 Connector with a Volt Meter, if a voltage of -3V to -15V is achieved, the device is DTE. If the voltage is on Pin 2, then the device is DCE.

Note: The result for a DB-25 Connector is reversed (Please refer to DB-9 to DB-25 conversion table)

RS-232 Pin outs (DB-9)

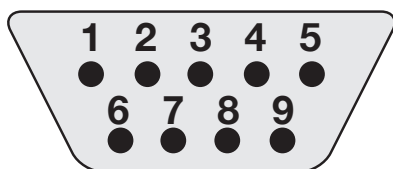

A male DB-9 connector viewed from the front.
Reverse or back view of male connector for Female Connector.

DB-9 to DB-25 Conversion

DB-9	DB-25	Function
1	8	DCD Data Carrier Detect
2	3	RxD Receive Data
3	2	TxD Transmit Data
4	20	DTR Data Terminal Ready
5	7	GND Ground (Signal)
6	6	DSR Data Set Ready
7	4	RTS Request to Send
8	5	CTS Clear to Send
9	22	RI Ring Indicator

DTE Pin Assignment (DB-9)

1	DCD	Data Carrier Detect
2	RxD	Receive Data
3	TxD	Transmit Data
4	DTR	Data Terminal Ready
5	GND	Ground (Signal)
6	DSR	Data Set Ready
7	RTS	Request to Send
8	CTS	Clear to Send
9	RI	Ring Indicator

DCE Pin Assignment (DB-9)

1	DCD	Data Carrier Detect
2	TxD	Transmit Data
3	RxD	Receive Data
4	DSR	Data Set Ready
5	GND	Ground (Signal)
6	DTR	Data Terminal Ready
7	CTS	Clear to Send
8	RTS	Request to Send
9	RI	Ring Indicator

RS-232 Connections

A straight-through cable should be used to connect a DTE (e.g. computer) to a DCE (e.g. AMP, matrix or modem), with all signals from one side connected to the corresponding signals on the other side in a one-to-one basis.

A crossover (null-modem) cable can be used to connect two DTE directly, without a modem in between to cross transmit and receive data signals between the two sides. There are numerous variations on how control signals are wired:

Straight-through (DB-9)

(DTE)		(DCE)	
1	DCD	-----	DCD
2	RxD	-----	TxD
3	TxD	-----	RxD
4	DTR	-----	DSR
5	GND	-----	GND
6	DSR	-----	DTR
7	RTS	-----	CTS
8	CTS	-----	RTS
9	RI	-----	RI

Crossover (Null-Modem) (DB-9)

(DTE)		(DCE)	
1	DCD	-----	DCD
2	RxD	-----	TxD
3	TxD	-----	RxD
4	DTR	-----	DSR
5	GND	-----	GND
6	DSR	-----	DTR
7	RTS	-----	CTS
8	CTS	-----	RTS
9	RI	-----	RI

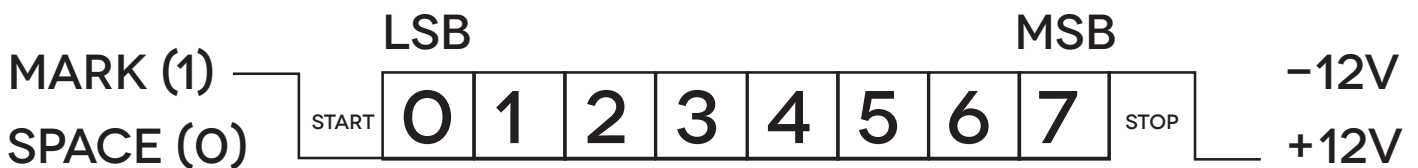

RS-232 Logic Waveform (8N1)

The graphic above illustrates a typical RS-232 logic waveform (Data format: 1 Start bit, 8 Data bits, No Parity, 1 Stop bit). The data transmission starts with a Start bit, followed by the data bits (LSB sent first and MSB sent last), and ends with a "Stop" bit.

The voltage of Logic "1" (Mark) is between -3VDC to -15VDC, while the Logic "0" (Space) is between +3VDC to +15VDC.

RS-232 connects the Ground of 2 different devices together, which is the so-called "Unbalanced" connection. An unbalanced connection is more susceptible to noise, and has a distance limitation of 15m/49ft.

12ii. Zonal IR for Cascading Multiple Independently Controlled AMP units

Individual IR Receivers for Independent Operation

Independent Zonal IR control is possible for individual, daisy-chained AMPs using separate IR receivers at display points.

Full Control of Each and Every Amp

Individual IR Receivers enables commands to be sent to AMPs separately.

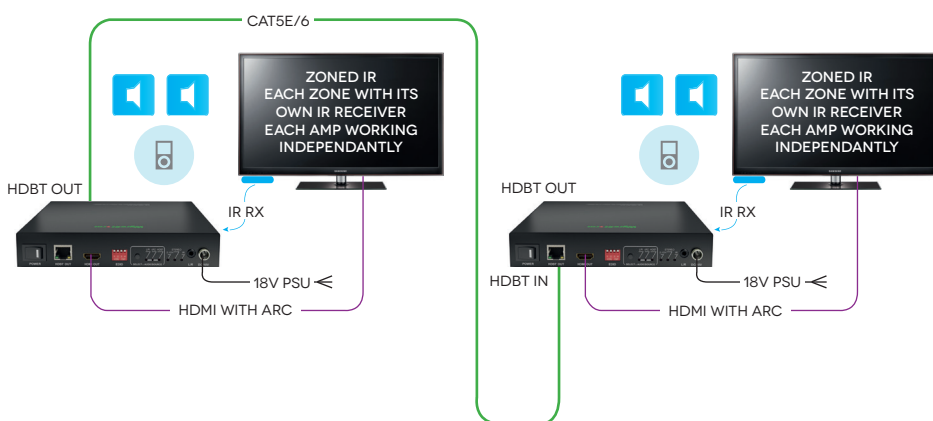

12iii. Global IR for Cascading Multiple Collectively controlled AMP units

Collective Control with a single IR Receiver, Only Final AMP with IR Receiver

Global IR control of a group of AMPs by All AMPs working together in terms of volume commands

Toggle Switch Control for ARC and Personal Audio Input

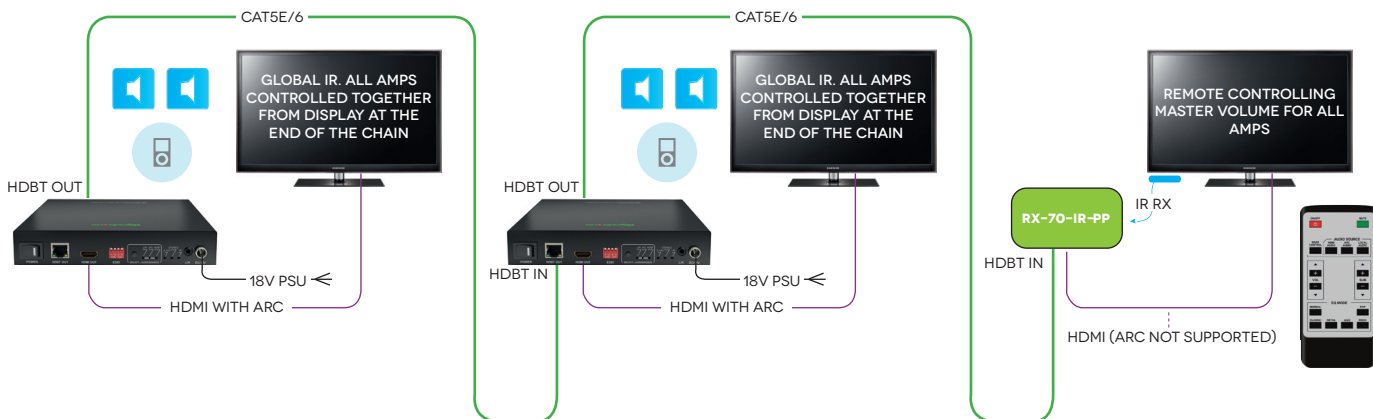

12iv. Hybrid IR for combination of Zonal and Global IR control of multiple AMP units

Final IR Receiver has overall control of all AMPs albeit with variations

Each AMP has local IR Control

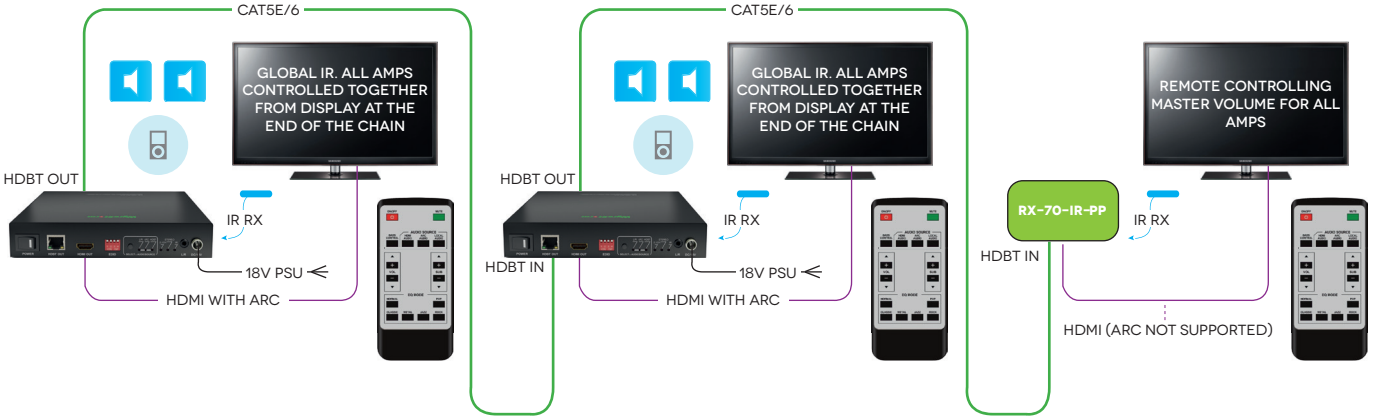

12v. RS232 Addressing

RS232 Addressing

Each AMP can be addressed so serial commands can be sent over HDBaseT to control specific AMPs at specific display points.

Software Solution

Control commands are sent from PC control software or a control system via the AMP RS232, ensuring correct COM port selection.

Choice of Control

Each AMP can be set up with individual or group addresses to enable control of a single AMP or group of AMPs.

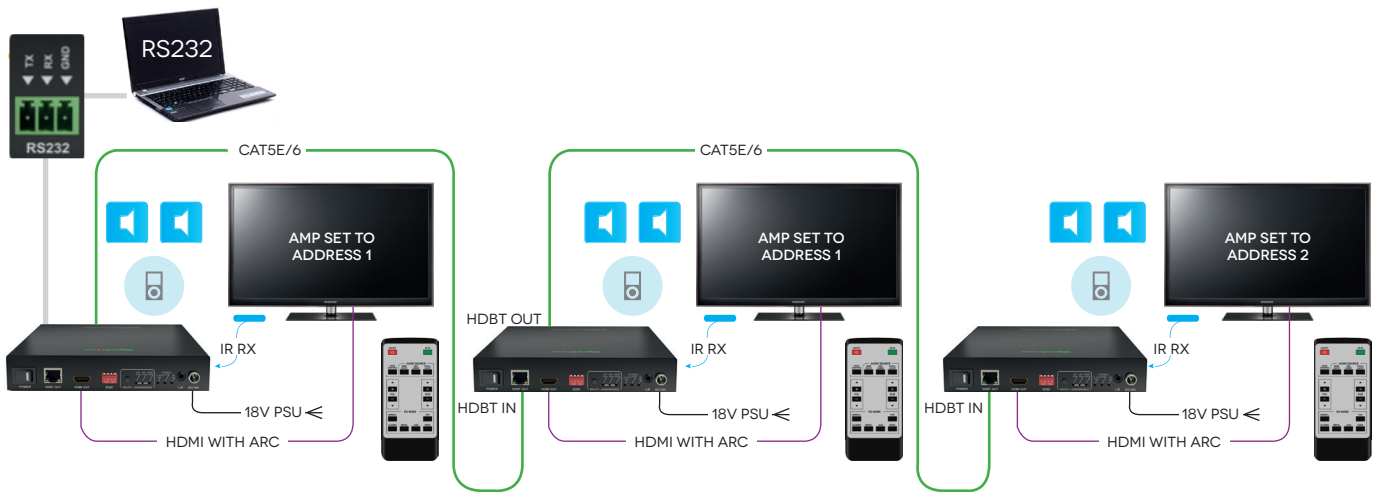

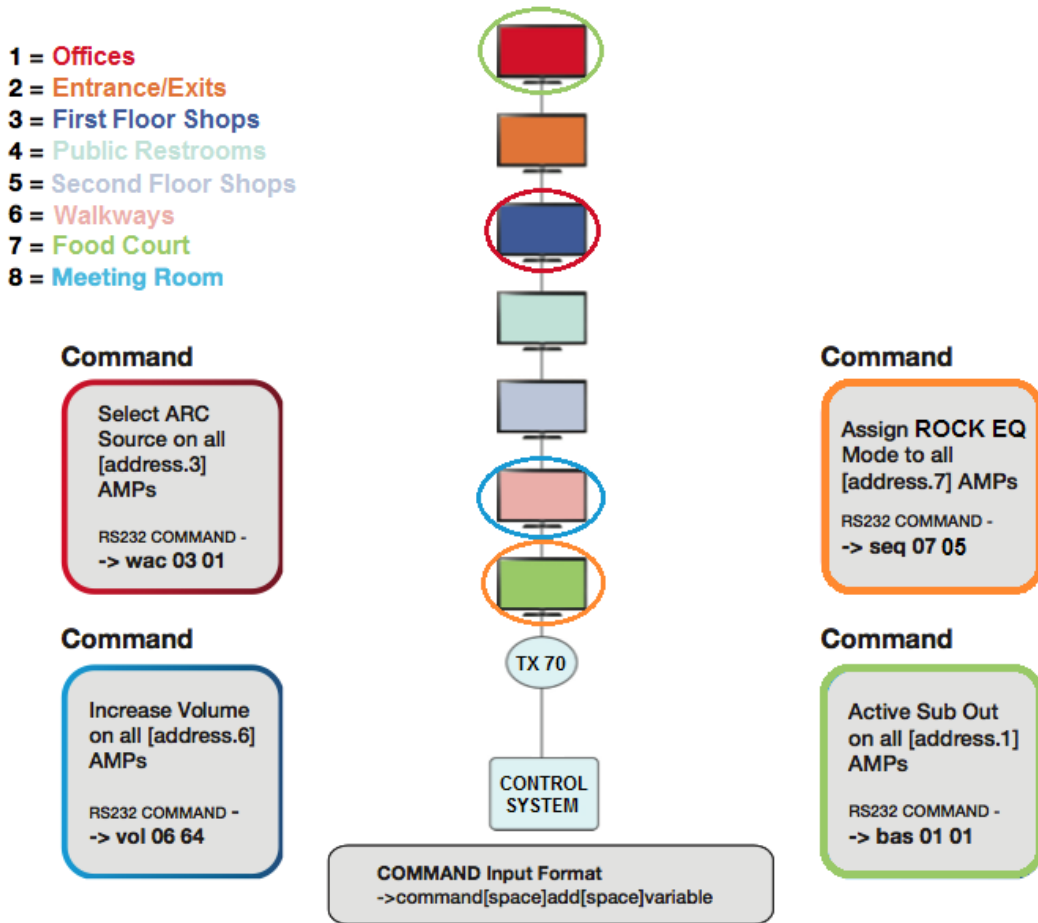

12vi. Routable RS232 with Wyrestorm POH enabled HDBaseT Matrices - MX-PP-POH

MX-PP-POH Range offers More for AMP Integration

The MX-PP-POH range are customizable Pro Plus matrices in 8x8 and 16x16 that offer a choice of 8 different analog and digital transmission cards, each converting to 70m/230ft HDBaseT Outputs.

More Power

As the name suggests, the MX-PP-POH feature Power-over-HDBaseT outputs, enabling power to be passed directly along the Cat5e/6 cable to a PoH-enabled receiver so no additional power is required at the display end.

AMP PoH Passthru

The AMP can be used as an PoH passthru device for power from a PoH matrix or transmitter to be carried to the PoH display receiver, but in this case the distance of PoH passing through the AMP is restricted to 50m/164ft. All functions of the AMP are maintained but the Amp itself requires mains power for operation.

More Control

PoH-enabled matrices also feature routable RS232 to allow each display zone to be independently controlled, which means up to 7 individually addressed AMPs can be connected to each output of the matrix, with serial control commands sent centrally through the RS232 port of the matrix to any specific Amp/group of Amps within the 8 or 16 separate control zones, depending on the matrix model.

Commands are simply sent to specific AMPs by their address, and ignored by others with a different address.

What Does This Mean?

Vast arrays of can be created easily by cascading multiple matrix switchers for possible distribution covering over 7.84km/4.86miles to 112 displays using the MX1616-PP-POH. This gives each display point its own fully routable AMP with control of matrix, sources, ARC and full access to local audio output and functions from the AMP user interface.

Note: AMP address and Control zone can be noted on the bottom of each unit. See EDID section

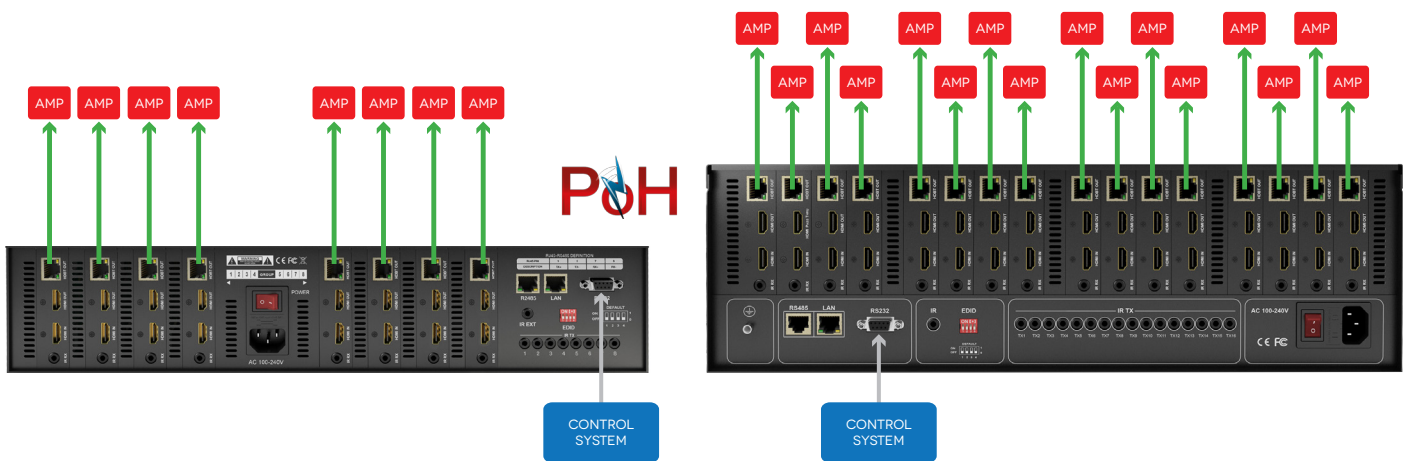

12vii. Residential RS232 HDBaseT Addressing example

Increase Volume

- > vol 05 64 [64 is command for up]
- > vol 03 64
- > vol 06 64

Active Sub Speaker

- > bas 02 01 [01 is command for on]
- > bas 01 01

Set Mute Function

- > mut 02
- > mut 06

COMMAND Input Format
->command[space]add[space]variable

- KEY:**
- AMP ADDRESS
 - M MATRIX
 - SPEAKER
 - SUBWOOFER

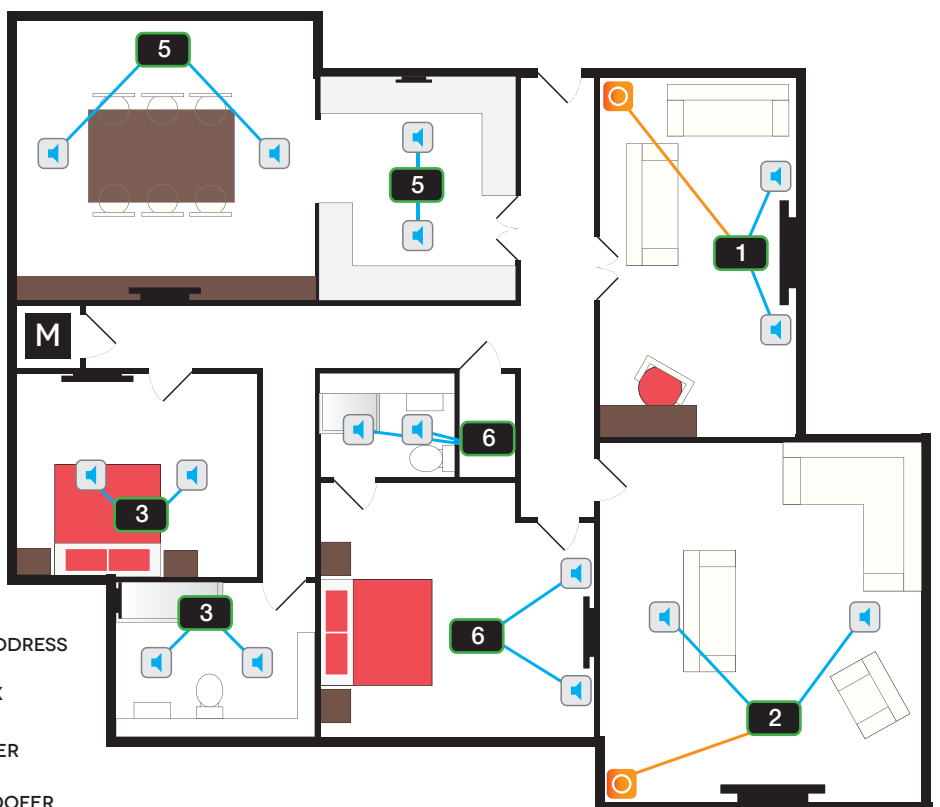

12viii. Example System Topology showing multiple, differently addressed Amps

- 1 = Offices
- 2 = Entrance/Exits
- 3 = First Floor Shops
- 4 = Public Restrooms
- 5 = Second Floor Shops
- 6 = Walkways
- 7 = Food Court
- 8 = Meeting Room

Command

Active Sub Out
on all [address.7]
AMPs

RS232 COMMAND -
-> **bas 07 01**

Command

Assign JAZZ EQ
Mode to all
[address.5] AMPs

RS232 COMMAND -
-> **seq 05 04**

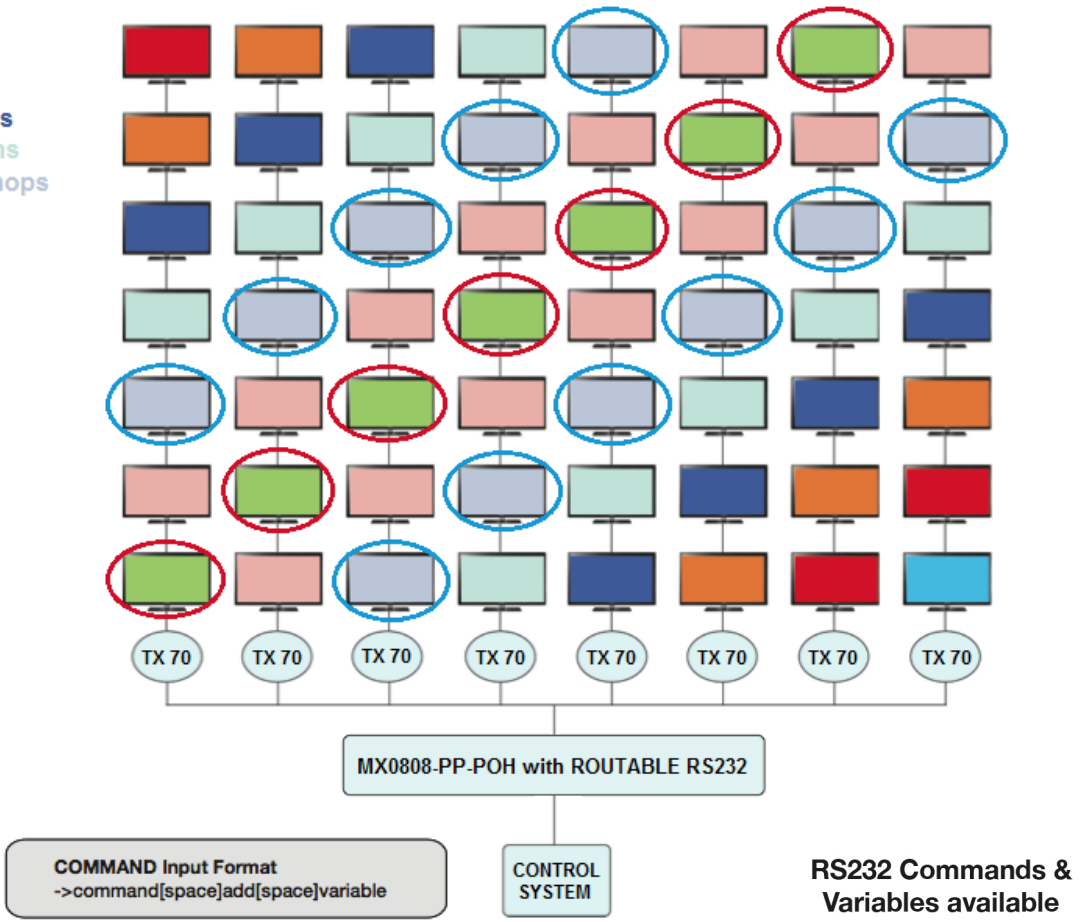

12ix. Commercial RS232 HDBaseT Addressing example

Mute Command

-> mut 03

Volume Down

-> vol 01 01

[01 is command for down]

COMMAND Input Format
->command[space]add[space]variable

KEY:

 AMP ADDRESS

 MATRIX



13i. EDID Management - About EDID

EDID (Extended Display Identification Data) is data generated from each display in the system to communicate the capabilities of the device (720p, 2ch Audio, 1080p, 7.1ch Audio).

For communication between devices to be made, and successful connection achieved, devices must both request and send the required information. For example, a display will communicate 1080p capability with 2ch audio, which the source device will accept and output the correct format for the display. Problems can arise when different types of devices such as displays, sources and amplifiers are used within a system, making communication between them that much more difficult; sometimes resulting in connection problems.

In such instances EDID needs to be streamlined or guided for all devices to work together, with equipment such as the AMP-001-010 perfectly placed to handle this process

as communication between display and amplifier is the most important in the system. The effective control and management of EDID is essential for the success of any integration, with this being achieved in most cases using the default setting on the AMP-001-010.

13ii. Before EDID Adjustments

Should device communication or compatibility issues be encountered during installations, please refer to the EDID DIP settings below.

If the maximum capabilities of the display are known, for example 3D with 2Ch stereo audio, Matching EDID should be sent to the AMP-001-010, for example settings for 3D with 2 Channel Audio is Switch 3 to the down position.

If the specification of the display is not known, simply copy the EDID from the display to AMP, through the HDMI connection by selecting Switch 1 to the ON position, with remaining switches to the off position (up), power cycling the AMP and you are ready to go.

13iii. EDID Presets

EDID DIP Switch settings

1 (Down): ON
 0 (Up): OFF
 X: Either position - does not effect function

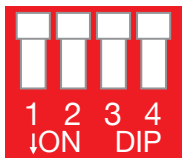

EDID subject to PC: settings via DIP switch deactivated adjustment by PC (Default Factory Setting)

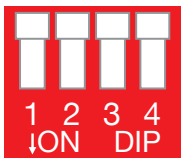

EDID set to copy HDMI OUTPUT EDID

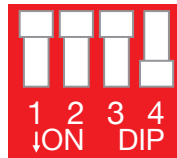

EDID set to copy HDBaseT OUTPUT EDID

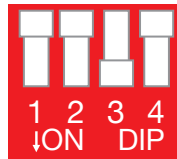

EDID set to fix 1080p 2ch stereo 3D

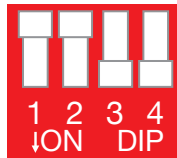

EDID set to fix 1080p 2ch stereo 2D

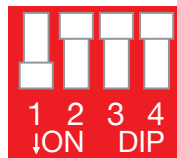

EDID subject to DIP switch: settings via PC deactivated adjustment by unit DIP switch

Attention: Any change to EDID settings will need a power down and power up cycle via the power switch.

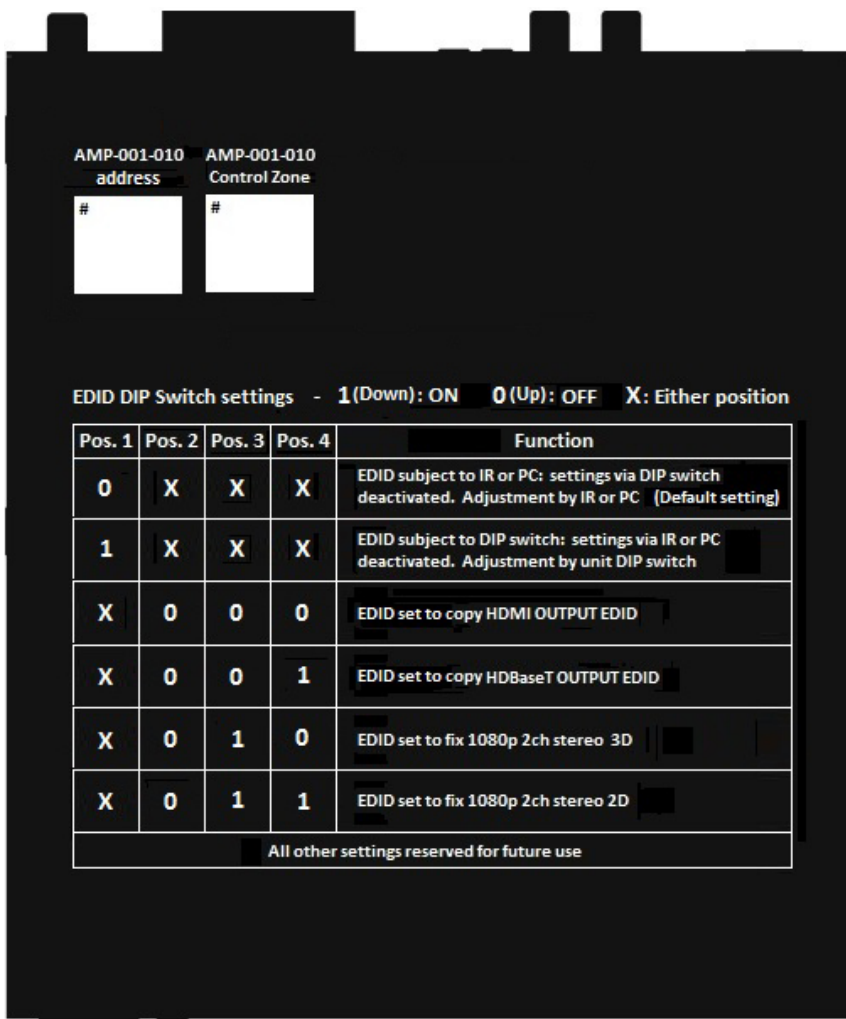

For convenience and ease of installation, on the underside of the AMP-001-010 you will also find the same EDID DIP settings as well as areas to write the Address of the AMP unit and the Control Zone it will be located in.

14. Troubleshooting

Generally, the majority of HD distribution installation issues are either caused by minor connection errors, communication problems between devices, or when the transmission of high signal bandwidth is attempted using insufficient cable. Should you encounter any technical difficulties when installing and configuring the matrix, we are confident solutions can be found by working through the following troubleshooting checklist before seeking alternative technical support.

No Picture or poor quality picture

1) Power – are all AMPs, HDBaseT transmitters or display receivers installed powered both ends? All units should have their own power source i.e. 18v for the AMP-001-010 and 5v for 70m.230ft HDBaseT Transmitters and Receivers – Please use power supplies included.

Note: Display receivers do not need to be independently powered if part of an HDBaseT PoH extender set or MX-PP-POH Matrix solution – there is a two-core power link between transmitter and receiver that powers the receiver at the display end. Non-PoH display receivers can also be powered via the display USB port by using the USB to 5v power cable also supplied with this model.

Are all sources definitely powered and firmly connected?

2) If possible, always use test equipment prior to installation and to troubleshoot any problems.



Test Monitor

Part Number TTMONITOR



Signal Generator

Part Number TTSIGNAL

3) Distance – Is the cable too long for the signal to be transmitted effectively? The HDBaseT classification used within the AMP-001-010, transmitters and receivers allow transmission of 1080p up to 70m/230ft so make sure the cable distance matches the project requirements and is well within the maximum transmission distance of the signal.

Note: If approaching the limits of the transmission capabilities, transmission should be extended by using another AMP or receiver to ensure the signal reaches its destination effectively.

4) Cable Joins – Joins in the cable run or RJ45 connectors can impact on signal strength, resulting in reduced transmission that may manifest itself in incorrect picture quality, picture dropping out or a complete lack of picture

5) Cable Choice and Signal Reduction – Are stranded patch leads being used as interconnects between patch panels or wall outlets? CCA (Copper Clad aluminium) cables being used? These can reduce transmission rates by up to 40% – we recommend solid core straight through with minimum connections used wherever possible.

6) Resolution: Speckles noticed in the picture – If the resolution of the source is reduced, is the result a clean and stable picture? If so, this could suggest a discrepancy between source and display resolution or a bandwidth capacity issue with the cable. Check that inputs and outputs share the same resolution and that the signal is being successfully transmitted along the cable run.

7) Correct connection – It may seem obvious but double check all UTP, HDMI, power and IR cables are connected to the correct ports.

Note: Even a fraction off can be the difference between a perfect picture and a blank screen. Double check all connections are firmly made in the correct ports.

8) Cable wired to 568B standard? Is the cable wired and terminated correctly and are those terminations connected to the correct ports? Incorrect wiring and termination will result in unstable operation or a blank screen.

9) Electrical interference – HDBaseT is less susceptible to interference compared to regular transmissions but the location of cables and devices should be considered - could any form of interference be generated? If so, attempt to remove the source of electrical interference or move the cable run to decrease the effects of the interference.

10) Is a picture achieved when connecting the source directly to the display? If not then the problem could lie with the input or output device rather than the means of distribution i.e. the cable, AMP or matrix itself.

11) HDMI lead condition and quality – HDMI cables and connectors are delicate and can be damaged much easier than component or coax cable. Furthermore, lead quality varies dramatically, particularly in lower price brackets. Swap HDMI leads and check operation – damage to or quality of your leads could be the problem. If in doubt, swap them over. Always take care inserting and extracting your HDMI from matrix ports so as not to damage the connectors or ports.

12) Picture speckles/HD 'noise' – represents a poorly established signal that may be caused by poor quality terminations, CCA, stranded or excessive cable lengths. Try swapping the display adaptors from a location that is functioning properly or swapping the outputs of the matrix switch used.

If the problem remains on the same screen this may be caused by a connection problem between matrix and display – turn off all equipment and swap the signal carrying cables at both ends to ascertain if the cable or termination is at fault.

HD Noise (NO image) may be an HDCP Issue between the source and display but poor cabling can also cause this due to poor communication.

13) Blu-ray: Deep Colour – make sure Deep Colour is turned on in your Blu-ray settings and displays.

14) Blu-ray: Resolution – if a reduction of resolution to 720/1080i produces an image, cable issues such as interference, patch panels, wall outlets, stranded cable use or excessive cable length are likely restricting transmission of a full 1080p signal.

15) Blu-ray: 3D – is the equipment used 3D enabled/compatible? Is a 3D disc being played in a 3D enabled Blu-ray player or through a compatible amplifier?

16) Colour distortion – a pink or green screen indicates an incompatibility between colour spacing formats – the commonly used RGB or YUV used by older displays. Some sources allow switching between RGB and YUV which may solve any colour problems. If not, try changing the HDMI cable between the source and the matrix to rule out defective cabling.

Audio is transmitted within the video signal – there is no separate audio track – so generally a problem with sound will be accompanied by a problem with picture. However, if technical issues with audio are experienced, the cause is typically communication between sources, displays and/or AV receiver settings.

No Sound or Poor Quality Audio

1) Have specific speaker sets or zones been enabled? Some AV receivers allow individual speaker selections assigned to specific zones in the set up so check the speakers used are fully connected to the amplifier and correctly assigned within the system set up. It may be an EDID issue in that the source reads the audio EDID from the display and only request's two channel audio and EDID copy from the AVR may be required or use an embedded EDID in the AMP or Matrix.

Note: If problems are experienced when an AV receiver is used, the cause is usually the settings of the AVR itself. Refer to the AVR manufacturer's guidelines on the correct settings to use for your requirements.

2) Consistency of audio output between devices – Is there any discrepancy between the audio output of the source, the audio or zonal settings of the AV receiver and the speaker configuration used needed for successful audio replication? If outputting 7.1, make sure all devices connected are also outputting 7.1

Note: Occasionally with some sources, the device settings allow the specification of audio output through a TV or an HDMI port. If using an AV receiver, check the HDMI output option is selected.

3) Do all the local sources work through the AV receiver?

Check the operation of each source individually.

Bandwidth

1) If using a graphics-based source (such as a PC/Mac/media server), make sure the source resolution is set to

a maximum of 1080p, 50Hz. Higher resolutions available for graphics-based systems require higher bandwidth that may affect transmission of signals as well as incompatibility with devices.

IR

1) Check emitters at the IR TX transmitter end and receivers at the IR RX receiver end – are they connected to the correct ports on the matrix and display receiver.

2) Is the emitter correctly positioned on the source?

Fix the emitter directly over the infrared sensor of the source and attach using the adhesive backing.

Note: Locate the infrared source sensor by using a flashlight to find small sensor within the fascia of the source display. If necessary, secure the emitter over the sensor with a small amount of contact adhesive.

3) Is the remote handset powered and sending a signal?

Note: IR is invisible to the naked eye, so use a digital camera/ phone camera to check the remote signal – point the camera at the remote control when pressing a button. The remote transmitter can be seen flashing to indicate a signal being sent. Replace batteries if flashing is not seen on the digital camera screen.

4) IR dropout issues can be due to exterior influences emitting infrared radiation that can interrupt IR signals. Ensure emitters and receivers are away from the following causes of IR interference.

- Direct sunlight, Fluorescent lighting (on cold start up)
- Halogen lighting
- Plasma screens, Candle light

5) UTP Termination Issues – ensure cables and RJ45 terminations are correct and in good condition at both transmitter and AMP/receiver ends to see if control is established. If so, a possible re-termination of the cable could remedy the problem.

6) Are Wyrestorm emitters and receivers being used? The use of third party products/magic eyes may not be compatible. Always use Wyrestorm components included with your purchase or check compatibility of third party control systems with your Wyrestorm dealer.

7) If problems persist, swap out the IR emitters and receivers to rule out faults with the units themselves. Use emitters you know are fully operational to test working condition.

8) Reactivate the IR call-back function on your matrix and swap IR ports on the matrix to rule out a fault with the matrix or connection ports.

9) Should IR remain unresponsive, turn off and disconnect all cables from the matrix and reconnect zones one at a time to assess if one location in particular is the problem. If so, run new cables directly to the display – if this fixes the problem, it is likely that electromagnetic interference / damage to the cable somewhere along the run is causing the IR signal to drop out. Investigate and remove EM interference from the run or replace damaged UTP cable.

15. FAQ'S

Cat5e or 6?

While our equipment is tested and graded to Cat 5e cable standard; tests have shown that better results are achieved when using Cat6 cable. The lower American Wire Gauge, thicker copper cores ensure better signal transfer/Transmission rates. Newly installed cabling should always conform to Part P Regulation and BS 7671 (17th Edition), and should be terminated to 568B standard.

Can I use a single Cat 5e/Cat 6 cable?

Although conventional transmission is considered to be two Cat 5e cables, HDBaseT transmission as used only requires a single cable; all of the twin cable features are supported with the added benefit of RS232 control and Ethernet on 100m/328ft HDBaseT products, with 70m/230ft HDBaseT products removing Ethernet passthrough functionality.

How far can the signal travel?

Under perfect transmission conditions our HDBaseT receivers will operate at 50m, 70m or 100m (@1080p) depending on the model used. Perfect conditions means no electrical interference, straight cable runs with no bends or kinks and no patch panels or wall outlets. If some of the above are factors in your installation then signal strength and bandwidth can be compromised. If a cable run is reaching the upper limit of the receivers' capabilities, then the signal can be boosted by way of an Amp set an in-line repeater. 7 times (490m) using HDBaseT technology.

What about 3D?

The AMP-001-010, all of our matrix switches and most of our extender products will pass-through a 3D Blu-ray signal.

How do I control the sources?

All of our HDMI distribution products support IR pass-through from point-to-point extender sets to AMP and HDBaseT matrices. Most of the range now supports wideband IR meaning it is compatible with any IR device available on the market. Our PP and HDBaseT matrix range (Cat 5e/Cat6) has IR pass-through from each of the outputs and has discrete IR outputs at the switch end, meaning you can have multiple identical sources yet the IR would be routed only to the applicable source.

Do I need power at the TV end?

Yes. Our AMP-001-010 HD display adaptors require a 18v power supply at the TV end to operate the POH receivers draw the power from an POH matrix or POH Transmitter NON POH devices require 5v. It's important that these are powered locally and do not receive remote power from the rack as there can be issues resulting from voltage drop along the length of cable. For non-PoH products, our USB to 5v power cables overcome the problem of having a second mains outlet behind the TV. These useful leads draw power from the USB port of the display to power the receiver, this also means that the receiver is only powered when the display is on making the system more energy efficient and environmentally friendly.

Do I need to use 1 or 2 cables?

Using our HDBaseT technology it's possible to send Audio (up to DTS Master), Video), and control (RS232 & 2-way IR) down a single Cat 5e/6 cable The FULL HDBaseT models also add video (up to 4k) and Ethernet (10/100).

Are Wyrestorm products compatible with HDMI 1.4?

HDMI 1.4 refers to a list of 'features' that a device is capable of supporting, including Ethernet channel, return audio channel, 3Detc. Due to the continuously evolving nature of the technology, HDMI Licensing LLC have now decided to simplify terminology by testing and referring to cable in terms of STANDARD or HIGH-SPEED rather than in generations 1.3, 1.4 etc.

- STANDARD (or "category 1") HDMI cables perform at speeds of 75Mhz or up to 6.75Gbps, which is the equivalent to a 720p/1080i signal – These HDMI cables are NOT recommended.
- All Wyrestorm equipment support HIGH-SPEED (or "category 2") HDMI cables that have been tested to perform at speeds of 340Mhz or up to 10.2Gbps, which is the highest bandwidth currently utilised over an HDMI cable and can successfully handle 1080p signals including those at increased colour depths and/or increased refresh rates from the Source. High-Speed cables are also able to accommodate higher resolution

displays, such as WQXGA cinema monitors (resolution of 2560 x 1600).

What about screens with different resolution capabilities?

When sending a signal point to point a TV will communicate it's capabilities to the source, then the source will output a suitable signal that compatible (i.e. 1080p Stereo audio). If you were to use a matrix switch with three 1080p screens and one 1080i screen, the resultant image would be 1080i across all screens. The matrix switches do not scale per output but instead negotiate with the source a signal that all screens are capable of supporting.

How does the Matrix cope with HDCP?

HDCP (High Definition Copyright Protection) is a feature built in to HDMI devices to prevent theft of or illegal distribution of HD content. Unlike competing products, Wyrestorm matrix switches are legal and comply with HDCP regulations. They do this by assigning a "key" to every display connected to the switch. HDCP "keys" are assigned to a display when connected to a HDMI device normally. This doesn't change when connected to a switch; it just assigns more of them.

I can get 1080i but not 1080p at a TV location

Firstly ensure that both the source is capable of outputting 1080p and that the TV is Full HD 1080p screen. If this is the case then the AMP, 70 metre receiver or PP Matrix may require EDID management setting up using the DIP switches. This useful feature provides a successful "send and receive" to ensure swift and stable EDID negotiation between the source and display. See Troubleshooting section for more tips on problem solving.

I cannot get a signal from my A/V receiver along a Cat 5e extender set

Check to ensure that the A/V Receiver isn't adding CEC (HDMI Control Protocol) to the outgoing signal, this can sometimes have an effect on the HDMI signal.

16. Maintenance

Clean this unit with a soft, dry cloth only. Never use alcohol, paint thinner or other harsh chemicals.

17. Provided Service

1. Damage requiring service: This unit should be serviced by a qualified service personnel if:

- The DC power supply or AC adaptor has been damaged.
- Objects or liquid have gotten into the unit.
- The unit has been exposed to rain.
- The unit does not operate normally or exhibits a marked change in performance.
- The unit has been dropped or the cabinet damaged.

2. Servicing Personnel: Do not attempt to service the unit beyond that described in these operating instructions. Refer all other servicing to authorised servicing personnel.

3. Replacement Parts: When parts need replacing, ensure parts approved by the manufacturer are used – either those specified by the manufacturer or parts possessing the same characteristics as the original parts. Be aware – unauthorised substitutes may result in fire, electric shock, or other hazards and will invalidate your warranty.

4. Safety Check: After repairs or service, ask the service personnel to perform safety checks to confirm the unit is in proper working condition. When shipping the unit, carefully pack and send it prepaid, with adequate insurance and preferably in the original packaging. Please include a document or letter detailing the reason for return and include a daytime telephone number and/or email address where you can be contacted.

18. Mail-in-service

If repair is required during the limited warranty period, the purchaser will be required to provide a sales receipt or other proof of purchase, indicating date and location of purchase as well as the price paid for the product. The customer will be charged for the repair of any unit received unless such information is provided.

19. Warranty

Should you feel your product does not function adequately due to defects in materials or workmanship,

we (referred to as “the warrantor”) will, for the length of the period indicated below (starting from the original date of purchase) either:

- Repair the product with new or refurbished parts.
- or
- Replace it with a new or refurbished product.

Limited warranty period:

All Wyrestorm products are covered by a 2 year PARTS and LABOUR warranty. During this period there will be no charge for unit repair, replacement of unit components or replacement of product if necessary.

The decision to repair or replace will be made by the warrantor. The purchaser must mail-in the product during the warranty period. This limited warranty only covers the product purchased as new and is extended to the original purchaser only. It is non-transferable to subsequent owners, even during the warranty period.

A purchase receipt or other proof of original purchase date is required for the limited warranty service.

19i. Warranty Limits and Exclusions

1. This Limited Warranty ONLY COVERS failures due to defects in materials or workmanship and DOES NOT COVER normal wear and tear or cosmetic damage.

The limited warranty also DOES NOT COVER damage that occurs in shipment or failures caused by products not supplied by the warrantor, failures resulting from accident, misuse, abuse, neglect, mishandling, misapplication, alteration, incorrect installation, set-up adjustment, implementation of/to consumer controls, improper maintenance, power line surge, lightening damage, modification, service by anyone other than a manufacturer-approved service centre or factory-authorized personnel, or damage attributable to acts of God.

2. There are no express warranties except as listed under “limited warranty coverage.” The warrantor is not liable for incidental or consequential damage resulting from the use of this product or arising out of any breach of this warranty.

For example: damages for lost time, the cost of having a person/persons remove or re-install previously installed equipment, travel to and from service location, loss of or damage to media, images, data or other recorded/stored

content. The items listed here are not exclusive, but are for illustration only.

Parts and service not covered by this limited warranty are not the responsibility of the warrantor and should be considered the responsibility of the individual.

20. Installation Notes

AMP-001-010 Installation Reference Log

AMP Number	Amp Location	Connected Sources (incl. line level)	Resolution & audio settings	Speakers/Subwoofer Connected	Preout to AVR	RS232 Control	Control Zone	Matrix Output	Cable Number	Matrix number (if cascaded)



www.wyrestorm.com

■ WyreStorm Offices

US Office: 6991 Appling Farms Parkway, Suite 104, Memphis, TN 38133

Tel: + 1 901 384 3575 Fax: + 1 901 384 3574

Unit 22, Ergo Business Park, Swindon, Wiltshire, SN3 3JW UK

Tel: +44 (0) 1793 230 343 Fax: +44 (0) 1793 230 583

■ WyreStorm Technical Support

US: +1 866 677 0053

UK:- +44 (0) 1793 238 338

Email: support@wyrestorm.com

We reserve the right to change specification or product dimensions at any time.